



SCIGATE AUTOMATION (S) PTE LTD

No.1 Bukit Batok Street 22 #01-01 Singapore 659592

Tel: (65) 6561 0488

Fax: (65) 6562 0588

Email: sales@scigate.com.sg

Web: www.scigate.com.sg

Business Hours: Monday - Friday 8.30am - 6.15pm

OPC Server for Pro-Server EX Reference Manual



PREFACE

Thank you for choosing 'OPC Server for Pro-Server EX' by Digital Electronics Corporation.

Please read this manual and the reference manuals thoroughly before use to understand how to operate this product safely and correctly.

Please be sure to keep the manuals handy at all times.

NOTE

- (1) The copyrights to all programs and manuals included in the 'OPC Server for Pro-Server EX' (referred to as "this product") are reserved by the Digital Electronics Corporation. Digital grants the use of this product to its users as described in the "Software Operating and License Conditions" section. Any actions violating the above-mentioned conditions are prohibited by both Japanese and foreign regulations.
- (2) The contents of this manual have been thoroughly checked. However, if you should find any errors or omissions in this manual, please contact the Pro-face and inform them of your findings.
- (3) Please be aware that Digital Electronics Corporation shall not be held liable by the user for any damages, losses, or third party claims arising from the use of this product.
- (4) Differences may occur between the descriptions found in this manual and the actual functioning of this product. The latest information about this product is provided in the accompanying data files (i.e. Readme.txt files, etc.) and/or separate documents. Please consult these sources prior to use as well as this manual prior to use.
- (5) Even though the information contained in and displayed by this product may be related to intangible or intellectual properties of the Digital Electronics Corporation or third parties, the Digital Electronics Corporation shall not warrant or grant the use of said properties to any users and/or other third parties. In addition, the Digital Electronics Corporation shall not be liable for any problems related to the rights of the third party, including intellectual property rights, arising from use or misuse of information recorded or displayed in this product.

Copyright (C) 2016.07 Digital Electronics Corporation. All rights reserved.

OPC Server for Pro-Server EX Reference Manual

PREFACE	1
NOTE	2
TRADEMARK RIGHTS	6
DESCRIPTION RULES	7
PRECAUTIONS	9

1 OPC DA

1.1	Functions and Features of OPC DA Specification	1-3
1.1.1	Overview	1-3
1.1.2	Access Method	1-5
1.1.3	Process Data	1-6
1.2	Operating Environment	1-7
1.3	System Configuration and System Required	1-9
1.4	Features of the OPC Server	1-11
1.5	Feature Configuration of the OPC Server	1-13
1.5.1	Software Configuration of the OPC Server	1-13
1.5.2	Correspondence of ItemID and Node, Device/PLC, Symbol	1-14
1.5.3	Item Data Configuration	1-15
1.5.4	Performance Adjustment Function	1-16
1.5.5	Simulation Function	1-17
1.5.6	Configuration Information of the OPC Server	1-19
1.5.7	Interfaces Supported by the OPC Server	1-20

2 Configuring the OPC Server

2.1	Configuration Workflow	2-2
2.2	Precautions when Configuring the OPC Server	2-4
2.3	Starting the Configuration Tool	2-5
2.3.1	Screen Configuration	2-6
2.3.2	Menu Bar	2-10
2.4	Registering a Tag	2-11
2.4.1	Tag Registering a Symbol	2-11
2.4.2	Tag Registering a Device Address	2-13
2.4.3	Registering Detailed Tag Parameters	2-16
2.5	Confirming the Detailed Specification	2-18
2.5.1	Detailed Tag Parameters	2-18
2.5.2	Signal Condition	2-19
2.5.3	Lower Input-Range Limit and Upper Input-Range Limit	2-20
2.5.4	Item Property ID	2-22
2.6	Environment Setting When Operating OPC Server and OPC Client on Different PCs	2-24
2.6.1	Changing the "Local Security Policy"	2-24
2.6.2	Setting Windows Firewall	2-27
2.6.3	Setting DCOM on a PC with the OPC Server Running	2-30
2.6.4	Setting DCOM on a PC with the OPC Client Running	2-35

2.7	Operating the OPC Server as a Service	2-39
2.7.1	Environment Settings When Operating the OPC Server as a Service	2-39
2.7.2	Using 'Pro-Server EX' for Setting	2-42
2.7.3	Using 'OPC Server for Pro-Server EX' for Setting	2-43
2.7.4	Connecting 'OPC Client for Pro-Server EX' to 'OPC Server for Pro-Server EX' ...	2-44
2.7.5	Notes on Operating the OPC Server as a Service	2-44

3 Operating the OPC DA Client

3.1	Starting the OPC Client.....	3-2
3.1.1	Screen Configuration	3-3
3.1.2	Menu Bar	3-4
3.2	Connecting to and Disconnecting from the OPC Server.....	3-5
3.2.1	Connecting to the OPC Server	3-5
3.2.2	Disconnecting from the OPC Server	3-6
3.2.3	Checking the OPC Server Status	3-7
3.3	Synchronously Reading/Writing Item Data	3-8
3.3.1	Synchronously Reading Item Data	3-8
3.3.2	Synchronously Writing Item Data	3-12
3.4	Asynchronously Reading/Writing Item Data	3-17
3.4.1	Generating the Subscription (Group and Item Registration)	3-17
3.4.2	Editing Subscription	3-21
3.4.3	Deleting Subscription	3-22
3.4.4	Adding Items	3-23
3.4.5	Editing Items	3-26
3.5	Canceling and Restarting the Subscription Data Distribution	3-28
3.5.1	Using the Active/Inactive Group Setting	3-28
3.5.2	Using Asynchronous I/O Object	3-29
3.6	Editing and Deleting Items.....	3-30
3.6.1	Editing Items	3-30
3.6.2	Deleting Items	3-31
3.6.3	Activating Items	3-31
3.7	Asynchronously Reading/Writing Item Data in the Group.....	3-32
3.7.1	Asynchronously Reading Item Data in the Group	3-32
3.7.2	Asynchronously Writing Item Data in the Group	3-34
3.7.3	Refreshing Items	3-38
3.8	Synchronous Processing Group Items	3-39
3.8.1	Synchronously Reading Data from Group Items	3-39
3.8.2	Synchronously Writing Data into Group Items	3-41
3.9	Browsing OPC Server Items.....	3-44

4 Menu Configuration of the Configuration Tool

4.1	Menu Configuration of the Configuration Tool	4-2
4.1.1	File Menu	4-2
4.1.2	Edit Menu	4-4
4.1.3	Display Menu	4-8
4.1.4	OPC Server Menu	4-8
4.1.5	Tool Menu	4-11
4.1.6	Help Menu	4-13

5	Error Information	
5.1	Error Information	5-2
5.1.1	OPC Server Error Information	5-2
5.1.2	Configuration Tool Error Information	5-6
6	Inquiry	
6.1	Inquiry	6-2

TRADEMARK RIGHTS

All company or product names used in this manual are the trade names, trademarks (including registered trademarks) of those respective companies.

This document omits individual descriptions of each of these rights.

Microsoft, Windows, Windows Vista, Windows Server, and Internet Explorer, are registered trademarks or trademarks of Microsoft Corporation in the United States and/or other countries.

Intel, and Pentium, are trademarks of Intel Corporation in the United States and/or other countries.

The following terms differ from the formal trade names and trademarks indicated in this document.

Term used in this document	Formal Trade Name or Trademark
Windows 8	Microsoft ^(R) Windows ^(R) 8 Operating System
Windows 8.1	Microsoft ^(R) Windows ^(R) 8.1 Operating System
Windows Embedded Standard 7	Windows ^(R) Embedded Standard 7 Runtime (WS7P)(ESD)
Windows 7	Microsoft ^(R) Windows ^(R) 7 Operating System
Windows Vista	Microsoft ^(R) Windows Vista ^(R) Operating System
Windows XP	Microsoft ^(R) Windows ^(R) XP Operating System
Windows Server 2003	Microsoft ^(R) Windows Server ^(R) 2003 Operating System
Windows Server 2008	Microsoft ^(R) Windows Server ^(R) 2008 Operating System
Windows Server 2012	Microsoft ^(R) Windows Server ^(R) 2012 Operating System
Windows Server 2012 R2	Microsoft ^(R) Windows Server ^(R) 2012 R2 Operating System

DESCRIPTION RULES

■ Safety Symbols and Terms

This manual uses the following symbols and terms to identify important information related to the correct and safe operation of display units and 'OPC Server for Pro-Server EX'.

The symbols and the descriptions are as follows.



The addition of this symbol to a “Danger” or “Warning” safety label indicates that an electrical hazard exists, which will result in personal injury if the instructions are not followed.



This is the safety alert symbol. It is used to alert you to potential personal injury hazards. Obey all safety messages that follow this symbol to avoid possible injury or death.

DANGER

DANGER indicates a hazardous situation which, if not avoided, will result in death or serious injury.

WARNING

WARNING indicates a hazardous situation which, if not avoided, could result in death or serious injury.



CAUTION

CAUTION indicates a hazardous situation which, if not avoided, could result in minor or moderate injury.

NOTICE

NOTICE is used to address practices not related to physical injury.

■ General Information Symbols and Terms

Symbols	Description
	States precautions and restrictions that must be followed.
	Provides tips on correct product use or supplementary information.
1, 2	Indicates an operation procedure. Follow the numbered steps.

■ How to Read the Manual

This manual describes how to operate "OPC Server for Pro-Server EX".
Please also refer to the related manual (Pro-Server EX Reference Manual).

■ Global Code

A global code is assigned to every Pro-face product as a universal model number. For more information on product models and their matching global codes, please refer to the following URL:

<http://www.pro-face.com/product/globalcode.html>

PRECAUTIONS

This manual describes safety symbols and terms for the correct and safe operation of 'OPC Server for Pro-Server EX'. Please read this manual and all related manuals carefully to understand the correct operation and features.

<i>NOTICE</i>

Disk Handling

- DO NOT touch the recording side of the DVD-ROM.
- DO NOT remove the DVD-ROM while the disk drive light is ON.
- DO NOT store the disk in an area exposed to the extreme high or low temperatures and/or high levels of moisture or dust.

Failure to follow these instructions can result in equipment damage.

<i>NOTICE</i>

LOSS OF DATA

- DO NOT turn off the main power to the PC while the program is running.

Failure to follow these instructions can result in equipment damage.

1



OPC DA

1.1	Functions and Features of OPC DA Specification	1-3
1.2	Operating Environment	1-7
1.3	System Configuration and System Required	1-9
1.4	Features of the OPC Server.....	1-11
1.5	Feature Configuration of the OPC Server	1-13

1 OPC DA

OPC DA (Data Access) is one of OPC specifications and was first defined and used more often than other OPC specifications. As shown in the table below, three major versions have been released. (as of April, 2012)

The purpose of OPC DA is to standardize the process data (Refer to "1.1.3 Process Data" for more details) handled in manufacturing fields when exchanging data.

Before OPC appeared, drivers were created according to the vendor-specific interface specification, which prevented smooth interconnection across multiple vendors. As a solution, OPC-F (OPC Foundation) released OPC DA, and the interface became standardized.

At present, the interoperability of OPC has been recognized, and it has become the de facto standard of interface for interconnection across multiple vendors.

'OPC Server for Pro-Server EX' complies with OPC DA 3.0 and OPC DA 2.05A specifications.

Released date	Version	Description
Aug., 1996	DA 1.0	Released
May, 1997	DA 1.0A	Minor update
Nov., 1998	DA 2.0	Release (revision of asynchronous)
Jul., 1999	DA 2.03	Minor update
Sep., 2000	DA 2.04	Minor update
Jan., 2002	DA 2.05	Minor update
Jun., 2002	DA 2.05A	Minor update
Mar., 2003	DA 3.0	Released

NOTE

- Each major version above differs in the interface that is defined in the server, as well as the group object. Note that it is recommended that the functions in lower versions should be implemented for the server.

As to the specific differences, the asynchronous access method has been changed from DA 1.0 to DA 2.0. Therefore, IOPCAsyncIO of the asynchronous interface defined in DA 1.0 has become optional in DA 2.0, and IOPCAsyncIO2 has been defined as the fundamental interface in its place. DA 3.0 has changed substantially, including compliance with XML-DA specification. Along with the function addition, seven interfaces have been added. Support descriptions have also been reviewed, and interfaces implemented less frequently within the optional interfaces have not been defined.

1.1 Functions and Features of OPC DA Specification

1.1.1 Overview

Server and group are defined as objects in OPC DA. Following this, the interfaces are defined for these objects. In addition, there are the item, cache, and device as abstract concepts required for regulating server operation. The OPC DA functions include reading and writing of process data (Refer to "1.1.3 Process Data" for more details). There are also auxiliary functions to browse the items, and save/load the configuration information of the OPC DA server.

A concept model for the OPC DA specification is shown below.

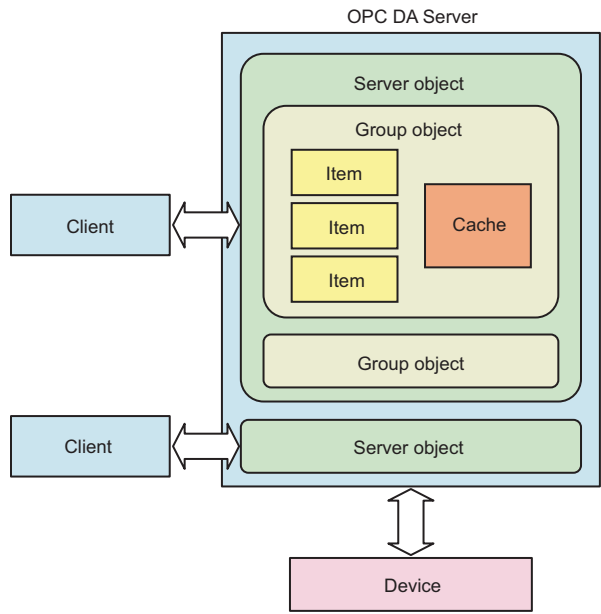

One feature of OPC DA is that it has data cache on the OPC DA server and that it defines the synchronous/asynchronous access methods in data reading and writing.

The data cache is intended to prevent responses from decreasing by accessing a low-speed lower device, and to implement the Subscription. Servers without the cache need to access a lower device for every client request.

With synchronous reading, the server access time when connecting to a lower device is included in the response time, which means longer response time due to the resulting slower access speed.

Adopting the cache can counter decrease in the response performance. In terms of synchronous reading, the cache or device can be specified as the destination for the acquired data. By adopting the cache, the OPC DA Server cache is regularly updated according to the update rate specified by the OPC DA Client. If the server detects a change in data in updating the cache, the OPC DA Server performs a callback to the OPC DA Client as Subscription. This function enables the OPC DA Client to always acquire the latest data without actually accessing the data.

In Subscription, you can also specify DeadBand which can disable a constant width of change for the data with minute changes expected.

'OPC Server for Pro-Server EX' uses the cache to improve the data access response.

1.1.2 Access Method

OPC DA can access the process data (Refer to "1.1.3 Process Data" for more details) synchronously or asynchronously. When the OPC DA Client calls on the synchronous method, the processing on the OPC DA Client is blocked until processing on the OPC DA Server is complete.

With the asynchronous method, on the other hand, the OPC DA Server receives the request and returns it to the OPC DA Client. Following this, the OPC DA Server processes the received request, and when it is complete, the OPC DA Server performs the callback to the OPC DA Client.

This enables the OPC DA Client to perform different processing (ex. response by a user operation) simultaneously as the OPC DA Server is processing the request, which can improve the application operability and response.

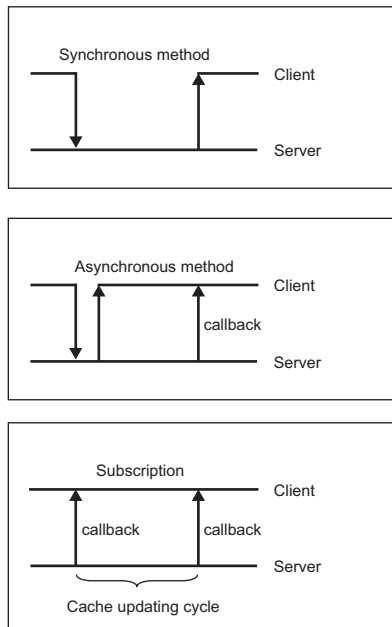

Such functions are intended to consider various OPC DA Server configurations, or OPC DA Client applications. Particularly, the asynchronous method and Subscription are expected to be used under SCADA (Supervisory Control And Data Acquisition) or HMI (Human Machine Interface). Using the asynchronous method enables performance of both data access and user operation. This can provide the improved response to the users. In addition, if you use Refresh (request the data of active items in a group, without item specification) or Subscription, you can decrease the overhead accompanied with the method call.

1.1.3 Process Data

The OPC DA data is comprised of the Value, Quality Flag and Time Stamp as shown below.

■ Value

Shows the current value of the specified item. The VARIANT type is used for the Value to handle all data type safely. The VARIANT type is a union which enables handling of the basic data type, as well as its alignment or character string. The OPC DA Client can request the type conversion from the data type of a specified item to the different data type.

■ Quality Flags

These flags show the value quality in three states: Good/Bad/Uncertain. For example, when the OPC DA Server, which has just started, does not access a lower device, the Quality Flags shows "Uncertain". When a lower device shows some errors, it is flagged as "Bad". The Quality Flags can show more detailed messages.

■ Time Stamp

Shows the time you acquired the value. When you specify the cache for reading, you can check the time point of the value acquisition.

1.2 Operating Environment

Check that the environment for this product conforms to the following conditions..

IMPORTANT

- This product must be installed and configured by qualified software installation staff with administrator rights.

Item	Requirements
OS	<p>PC/AT Compatible Machine</p> <ul style="list-style-type: none"> • Windows^(R) XP (Service Pack 3 or later) For 32-bit versions, Professional Edition • Windows Vista^(R) For 32-bit versions, Ultimate Edition, Professional Edition, Home Premium Edition, Home Basic Edition, Business Edition, Enterprise Edition • Windows Server^(R) 2003 R2 For 32-bit versions, Standard Edition, Enterprise Edition • Windows^(R) 7 For 32/64-bit versions, Ultimate Edition, Professional Edition, Home Premium Edition, Home Basic Edition, Business Edition, Enterprise Edition • Windows^(R) 8 For 32/64-bit versions, Windows 8, Windows 8 Pro, Windows 8 Enterprise • Windows^(R) 8.1 For 32/64-bit versions, Windows 8.1, Windows 8.1 Pro, Windows 8.1 Enterprise • Windows Server^(R) 2008 For 32/64-bit versions, Standard Edition, Enterprise Edition, Datacenter Edition • Windows Server^(R) 2008 R2 Standard Edition, Enterprise Edition, Datacenter Edition • Windows Server^(R) 2012 Foundation Edition, Essentials Edition, Standard Edition, Datacenter Edition • Windows Server^(R) 2012 R2 Foundation Edition, Essentials Edition, Standard Edition, Datacenter Edition <p>SP5000 Series Open Box (SP-5B40) For 32-bit versions, Windows^(R) Embedded Standard 7</p> <p>PE4000B Series For 32-bit versions, Windows^(R) Embedded Standard 7</p>
CPU	1.30 GHz or faster x86 compatible processor
Memory	512 MB or more (2 GB or more recommended)
Hard Disk Space ^{*1}	600 MB or more (1.3 GB or more recommended)
Others programs	<ul style="list-style-type: none"> • Microsoft^(R) .NET Framework Ver.2.0^{*2} • Microsoft^(R) Internet Explorer^(R) Ver.6.0 or later • Pro-Server EX Ver.1.20 or later

- *1 Free space required for installation.
- *2 When Pro-Server EX is installed, the .NET Framework is also automatically installed.

1.3 System Configuration and System Required

The system consists of the following four functions:

- Pro-Server EX
- OPC Server for Pro-Server EX (herein referred to as OPC Server)
- OPC Client for Pro-Server EX (herein referred to as OPC Client)
- OPC Server Configuration Tool for Pro-Server EX (herein referred to as Configuration Tool))

IMPORTANT • OPC Client supports OPC Server only.

NOTE • When you are using Windows Embedded machines, you can set the write filter (write protection) on drives installed with the operating system. If the write filter settings are enabled, disable the write filter settings (EWF Manager) before installing Pro-Server EX. Additionally, to install this product on the SP5000 series Open Box (SP-5B40), run installation from the Explorer Shell. For details, refer to the user manual for your unit.

An example of the OPC Server system configuration (including hardware and software) is shown below.

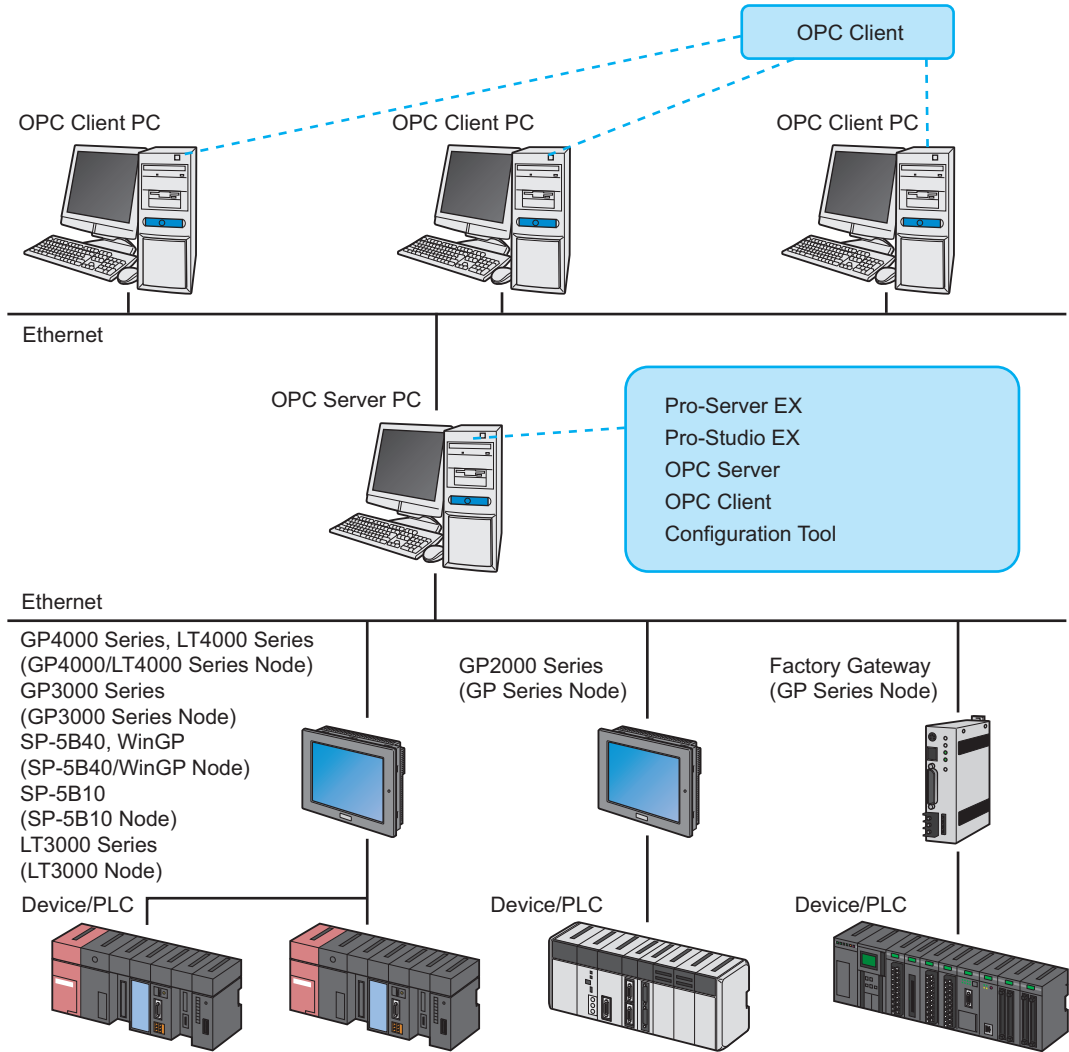

1.4 Features of the OPC Server

The OPC Server consists of the OPC DA Server of OPC DA (Data Access) version 3.0 or 2.05A specification, the Configuration Tool which creates the tag information controlled by the OPC Server, and the OPC Client which can read or write the item data of the OPC Server.

NOTE • The OPC Server is created on the basis of OPC DA 3.0 specification. The OPC Server also supports the interfaces of OPC DA 2.05A specification to maintain compatibility.

■ I/O Signal Condition Conversion and Scale Conversion are Available

If a tag-registered item is included in the Pro-Server EX data type shown in the table below, you can specify the signal conditions to perform the range conversion. To perform scale conversion with signal conditions, set the input range, instrument range, and decimal point position.

16-bit (Signed)	32-bit (Signed)	Single-precision floating point
16-bit (Unsigned)	32-bit (Unsigned)	Double-precision floating point
16-bit (HEX)	32-bit (HEX)	-
16-bit (BCD)	32-bit (BCD)	-

■ Simulation Function Included

The OPC Server can change the data by generating simulation data even when an actual device is not connected. To generate the simulation data, you can select either of the following methods: by specifying a function (ex. random number, trigonometric function) for each tag name, or by generating the data closest to the actual data by reading it from a CSV file.

■ Configuration Tool Provided

The OPC Server discloses all the symbols and device information controlled by 'Pro-Server EX' to the OPC Client, attaching conditions. The OPC Server attaches the Tag Names to the information for control, and discloses the tagged information as ItemIDs to the OPC Client. The OPC Client uses these ItemIDs to access the OPC Server.

The Configuration Tool is used to provide the following files for the OPC DA Server:

- Tag configuration files that show tagged information of the symbols managed by 'Pro-Server EX'.
- Configuration files that show the location and other information of tag configuration files.

Item IDs created by the Configuration Tool use the nodes or symbols specified in NPX created by 'Pro-Studio EX'.

■ **OPC Client Included as Standard**

The OPC Client can specify an ItemID of the OPC Server to monitor or change the data. Even users without the OPC Server knowledge can use the OPC Server functions through the OPC Client.

■ **ProgID and CLSID of the OPC Server**

ProgID, CLSID, LIBID, APPID, and Service Name of the OPC Server are shown below:

ProgID	Pro-face.OPCEX
CLSID	{51EF7402-B5B3-4f68-82A1-557492A79B4A}
LIBID	{15529293-1B7D-4c34-AEDE-52CC8F557A0E}
AppID	{21F66060-FEEC-4398-8543-2DEDFDA38912}
Service Name	Pro-face OPCEX Data Access 2.05a/3.00 Service

1.5 Feature Configuration of the OPC Server

1.5.1 Software Configuration of the OPC Server

The OPC Server is the multithreading data access server located between the OPC Client and 'Pro-Server EX' which controls the device data from remote nodes /connected devices (ex. PLC).

Software configuration of the OPC Server is shown below:

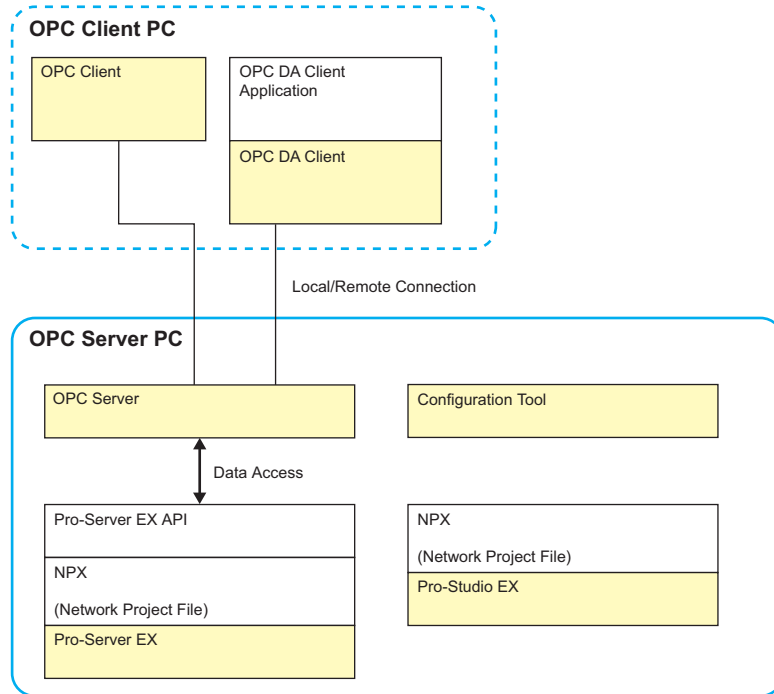

1.5.2 Correspondence of ItemID and Node, Device/PLC, Symbol

The OPC Server discloses an ID, called ItemID, uniquely defined on the OPC Server. The OPC Client uses this ItemID to read or write the actual device data.

You can register the same symbol name on the different sheets in 'Pro-Server EX', and the path through the node to the symbol is required to uniquely specify the symbol. Note that the sheet name is unnecessary when you directly attach the device address as a tag.

For this reason, ItemIDs on the OPC Server show the combination of each name from the node name to the symbol name using the dot '.', as well as the Device/PLC name for the cache registration in 'Pro-Studio EX'.

Therefore, you can easily understand by the ItemID which actual device on the configuration is shown from its format.

For example, the ItemID to enable the OPC Client to access the symbol data of "Temperature1" defined on Sheet 1, in PLC1 of AGP1, is "AGP1.PLC1.Sheet1.Temperature1".

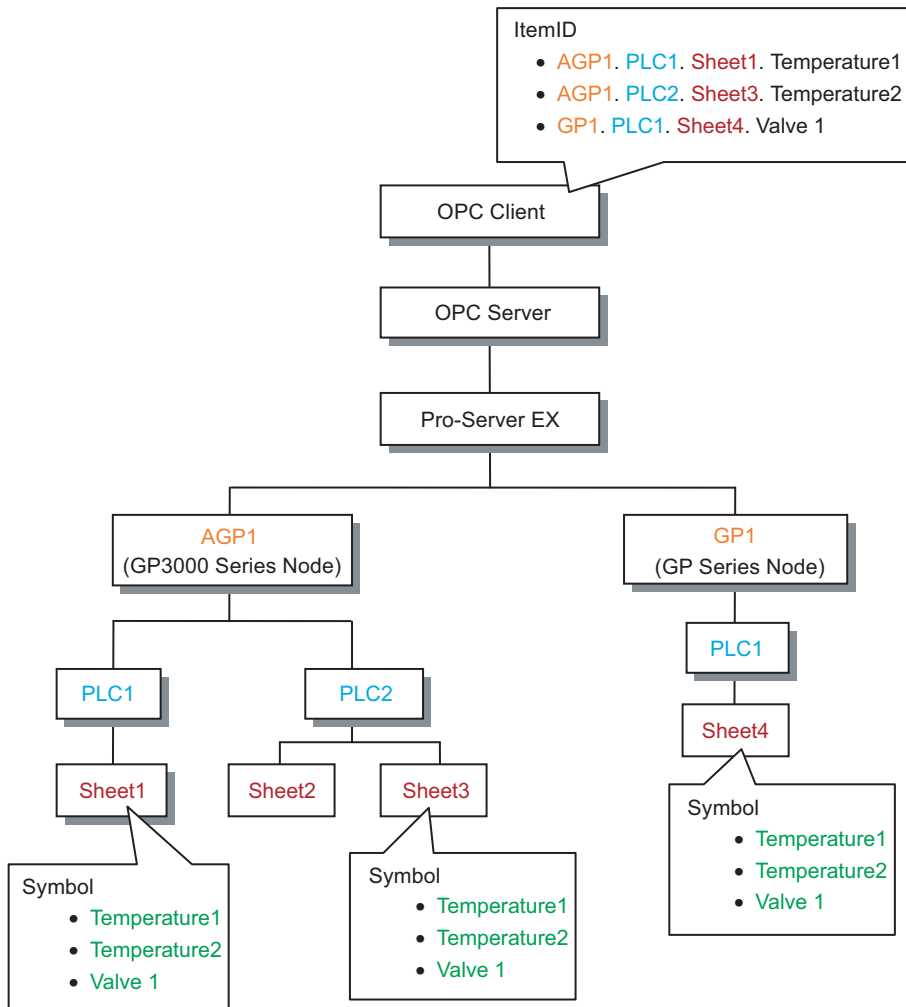

1.5.3 Item Data Configuration

The Item Data consists of three data: Value, Quality, and Time Stamp.

■ Value

The OPC Server specifies the signal conditions and scale on the device data specified as the Item to provide the data converted to the engineering unit value.

■ Quality

The Item quality is described in 8 bits of QQSSSSL. The OPC Server supports the quality shown below:

QQ (0 - 3)		SSSS (0 - 15)		LL (0 - 3)		Description
0	Bad	0	Unknown	0	No Deviation	Except 1 (Configuration Error), 4 (Sensor Error), 5 (Previous Value), 6 (Communication Error)
		1	Configuration Error	0	No Deviation	Description of the configuration file
		4	Sensor Error	1	Lower Limit Deviation	Deviates the lower limit of the input range.
				2	Upper Limit Deviation	Deviates the upper limit of the input range.
		5	Previous Value	0	No Deviation	Uses the previous value due to some communication errors.
		6	Communication Error	0	No Deviation	The previous value is not available due to some communication errors.
1	Uncertain	0	Unknown	0	No Deviation	Except 5 (engineering unit value)
		5	Engineering unit value	1	Lower Limit Deviation	Deviates the upper limit of the engineering unit value range.
				2	Upper Limit Deviation	Deviates the lower limit of the engineering unit value range.
3	Good	0	Normal	0	No Deviation	Normal

The OPC Server has its own information status. The description is shown below:

Server Status	Status	Description
OPC_STATUS_RUNNING	Normal	OPC Server is running

■ Time Stamp

The time when the item value is changed is set in Time Stamp. The time is based on the PC time on which the OPC Server is running.

1.5.4 Performance Adjustment Function

Scan Cycle List

The OPC Server can set the scan cycle for each tag to adjust the system performance.

You can select the scan cycle among nine types of cycles (you cannot change "Output only").

To set the scan cycle for the tag, select the desired cycle from [Scan Cycle List Settings] on the [OPC Server] menu. The "Output only" option is included in the scan cycle list to handle the tag used for writing data only. The data of the tag set to "Output only" is not read out.

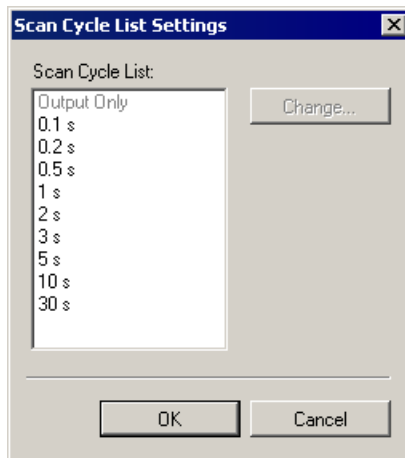

Tag Enabled/Disabled

The OPC Server can set to enabled or disabled for each node, group, or tag. If a node, group, or tag is disabled, the OPC Server does not create the ItemID for the disabled tag.

1.5.5 Simulation Function

The OPC Server supports the simulation function. You can set whether to enable/disable the simulation and its update rate in the configuration file. When the OPC Server is in the simulation mode, 'Pro-Server EX' does not start up. Note that 'Pro-Server EX' keeps running if it has already started.

There are six data types to generate the simulation: No data generation (None), Increment (Increment), Random number (Random), Sine wave (SIN), Cosine wave (COS), and CSV data (CSV). You can set the data type in "Simulation" under the Item properties for each tag.

Type	Description	Notes
None	Does not specify the simulation	
Increment	Increment	String not supported
Random	Random number	String not supported
SIN	Sine wave	String not supported
COS	Cosine wave	String not supported
CSV	CSV File	String supported

When you specify a CSV file, read the data from the CSV file to write it. An example of CSV file format is shown below:

- 1st line: Describe the tag name.
- 2nd line or later: Describe the data.

When the tag data type is bit, the CSV file uses "On" when its value is 1, and "Off" when its value is 0.

NOTE • As uppercase/lowercase characters are differentiated, operation is invalid if you use "ON" or "OFF".

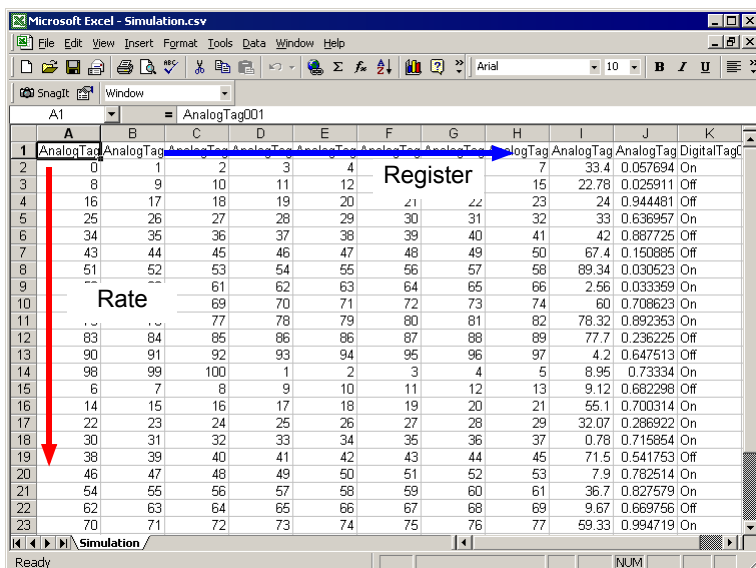

The OPC Server reads the CSV file column-wise in the order of registration for the tags with the Simulation set (returns to the 1st column when reaches to the last column, and repeats).

It reads row-wise with the simulation rate set in the configuration file (returns to the 1st row when reaches to the last row, and repeats). The OPC Server does not perform the simulation for the tags without the Simulation set.

1.5.6 Configuration Information of the OPC Server

The OPC Server consists of the configuration file (OpcConfiguration.xml) created with the Configuration Tool and the tag configuration file (TagConfiguration.xml).

Follow the steps below to create the configuration file.

- 1 Start the Configuration Tool.
- 2 Select [OPC Server Configuration Settings] from the [OPC Server] menu.

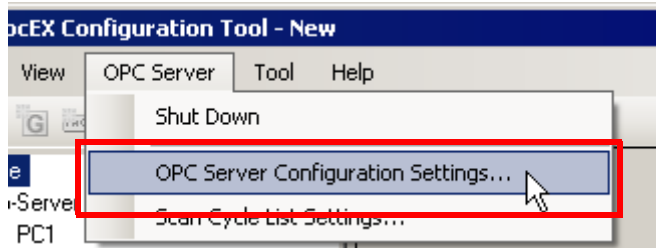

- 3 In the [OPC Server Configuration Settings] dialog box, set the configuration file, output log and simulation. Click [OK] to create the configuration file.

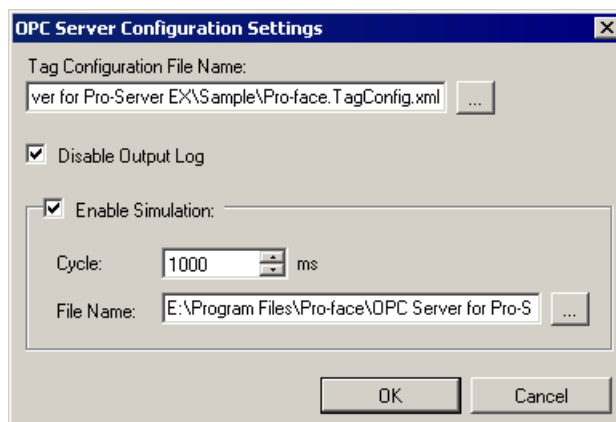

-
- NOTE** • You can also create the tag configuration file using the Configuration Tool. For more details on how to create the configuration information, refer to "2 Configuring the OPC Server".
-

1.5.7 Interfaces Supported by the OPC Server

The OPC Server complies with OPC DA 2.05A/3.0. Interfaces supported by the OPC Server are shown below. (supports the interface with "O" shown in the OPC Server column).

Data Access Server I/F	DA1.0	DA2.0	DA3.0	OPC Server
OPC Server Object				
IUnknown	Required	Required	Required	○
IOPCServer	Required	Required	Required	○
IOPCCommon	N/A	Required	Required	○
IConnectionPointContainer	N/A	Required	Required	○
IOPCItemProperties	N/A	Required	N/A	○
IOPCBrowse	N/A	N/A	Required	○
IOPCServerPublicGroups	Optional	Optional	N/A	
IOPCBrowseServerAddressSpace	Optional	Optional	N/A	○
IOPCItemIO	N/A	N/A	Required	○
IProFaceShutdown	N/A	N/A	N/A	○
OPC Group Object				
IUnknown	Required	Required	Required	○
IOPCItemMgt	Required	Required	Required	○
IOPCGroupStateMgt	Required	Required	Required	○
IOPCGroupStateMgt2	N/A	N/A	Required	○
IOPCPublicGroupStateMgt	Optional	Optional	N/A	
IOPCSyncIO	Required	Required	Required	○
IOPCSyncIO2	N/A	N/A	Required	○
IOPCAsyncIO2	N/A	Required	Required	○
IOPCAsyncIO3	N/A	N/A	Required	○
IOPCItemDeadbandMgt	N/A	N/A	Required	○
IOPCItemSamplingMgt	N/A	N/A	Optional	
IConnectionPointContainer	N/A	Required	Required	○
IOPCAsyncIO	Required	Optional	N/A	
IDataObject	Required	Optional	N/A	
EnumOPCItemAttributes				
IEnumOPCItemAttributes	Required	Required	Required	○
Client Side Interface				
IOPCDataCallback	N/A	Required	Required	○
IOPCShutdown	N/A	Required	Required	○

2



Configuring the OPC Server

2.1	Configuration Workflow	2-2
2.2	Precautions when Configuring the OPC Server	2-4
2.3	Starting the Configuration Tool	2-5
2.4	Registering a Tag	2-11
2.5	Confirming the Detailed Specification	2-18
2.6	Environment Setting When Operating OPC Server and OPC Client on Different PCs	2-24
2.7	Operating the OPC Server as a Service.....	2-39

2 Configuring the OPC Server

2.1 Configuration Workflow

Use the Configuration Tool to set the OPC Server. This section shows the work description with the Configuration Tool and the workflow of the OPC Server configuration.

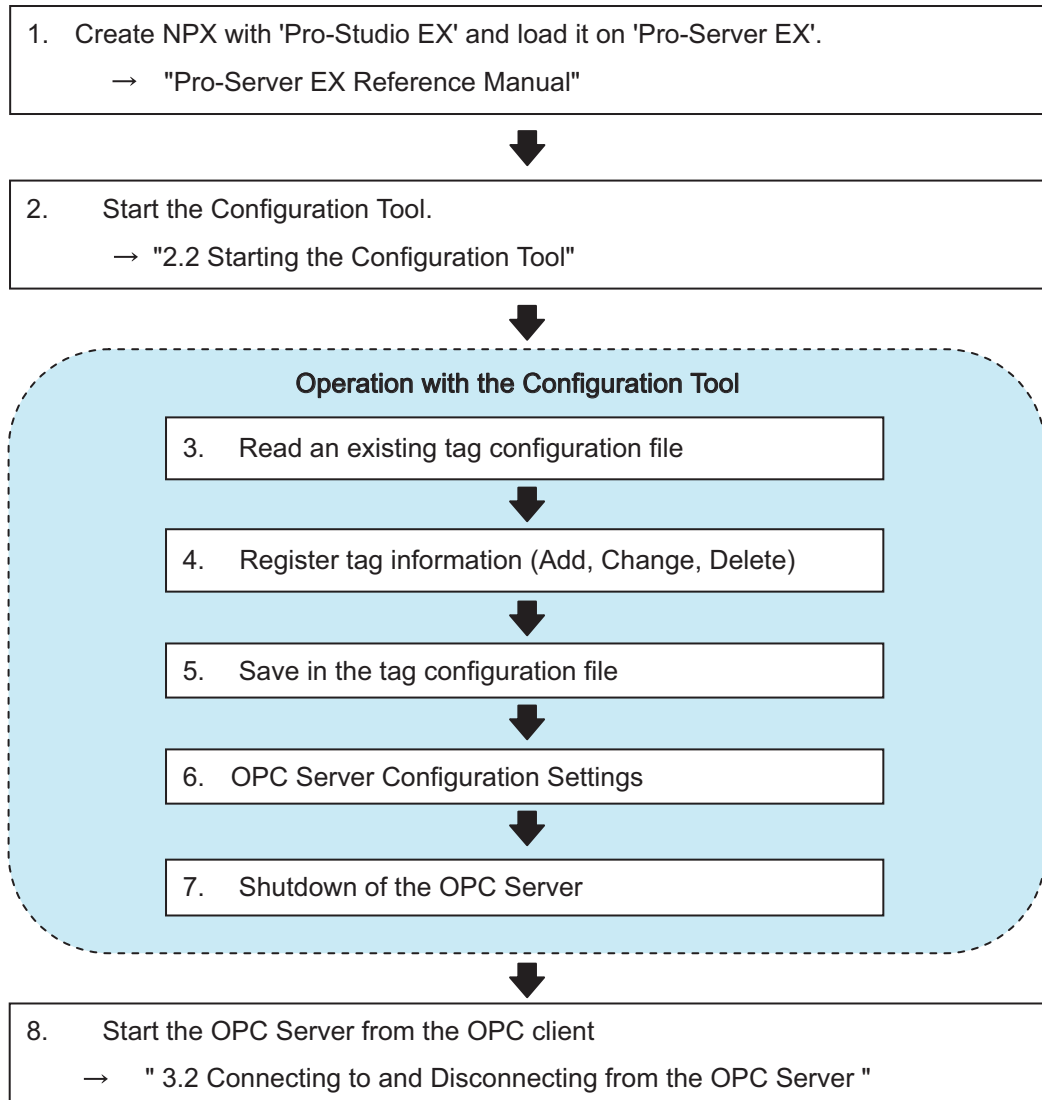

IMPORTANT

- If you operate the OPC Server and OPC Client on different PCs, you need to set up the environments for each PC. Refer to "2.6 Environment Setting When Operating OPC Server and OPC Client on Different PCs" for more details.
 - You can operate the OPC Server as Windows service. For more details, refer to "2.7 Operating the OPC Server as a Service".
 - While connected to the OPC Server, do not perform a reload using 'Pro-Server EX'. To change the network project, shut down all connections to the OPC Server before performing a reload.
 - While reloading a network project file on a network PC to Pro-Server EX, you cannot use OPC Server. Save the network project file you want to reload to the same PC where OPC Server is installed.
-

Outline of Steps

- (1) Create NPX with 'Pro-Studio EX' and load it using 'Pro-Server EX'.
- (2) The Configuration Tool reads the registration information related to the nodes and Device/PLCs from NPX of 'Pro-Server EX', and displays their device configurations.
- (3) When the existing configuration files need to be displayed or edited, the Configuration Tool reads the tag configuration file, and compares it with the node or Device/PLC information that has been read in step (2). It then displays the simple configuration to show the relationship between each Device/PLC and the tag.
- (4) Using the import function or each editing function including adding, editing or deleting the tag, register the tag corresponding to the symbol or device address.
- (5) Save the edited tag information as the tag configuration file.
- (6) To apply the saved tag configuration file on the OPC Server, specify the created tag configuration file as a configuration file in the OPC Server configuration.
- (7) To apply the configuration information onto the OPC Server, shut it down.
- (8) When the OPC Client connects to the OPC Server, the OPC Server restarts. Then, the tag configuration information on the OPC Server is updated to the tag configuration information shown in the configuration file.

2.2 Precautions when Configuring the OPC Server

This section describes precautions to take when configuring the OPC Server.

■ When using the OPC Server with a SP-5B40/WinGP node, SP-5B10 node, GP4000/LT4000 Series node, GP3000 Series node, or LT3000 node

In the following cases, it may take time for the OPC Server process to end.

- Many items are registered for multiple nodes.
- The OPC server cannot communicate with some nodes from which items are read because those nodes are not turned on, or are physically disconnected from the network.

To avoid the above problems, perform the following steps.

- 1 Start 'Pro-Studio EX'.
- 2 Select [Network Setup] in the [Setting] menu of 'Pro-Studio EX'.
- 3 Click [Node settings other than GP series node settings].
- 4 Set the smaller values in [TimeOut (ms)] and [Retry (times)] under [Default Settings].

NOTE • If you know which node cannot be connected in advance, specify the connection between that node and the Pro-Server EX node, where the OPC Server is running, under [Time-out period for slow line between nodes]. Also, set the time out period and retry frequency individually.

- 5 After completing the settings, transfer the network project to all nodes.

2.3 Starting the Configuration Tool

To start the Configuration Tool, select [Pro-face]-[OPC Server for Pro-Server EX]-[OPC Server Configuration Tool for Pro-Server EX] from the start menu.

IMPORTANT • Start the Configuration Tool on a PC with 'Pro-Server EX' installed.

NOTE • You can also double-click on the "OPC Server Configuration Tool for Pro-Server EX" shortcut on the desktop.



2.3.1 Screen Configuration

The Configuration Tool screen is comprised of the following five panes.

- 1) Station Explorer
- 2) ItemID View
- 3) Tag Parameter View
- 4) Error List
- 5) Tag Search Result

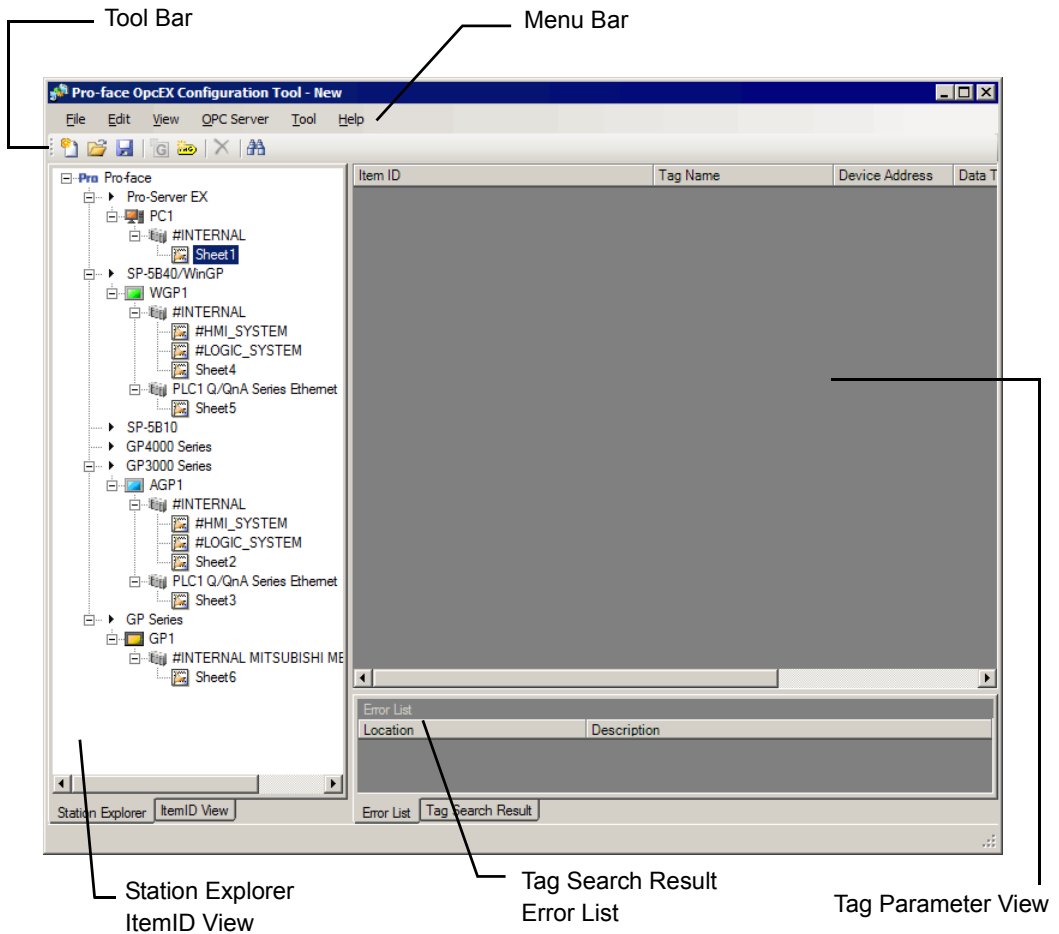

6 Station Explorer

Displays the nodes, Device/PLCs, and tag names in a hierarchical tree structure. Shown below are the icons displayed and their meaning.

Icon	Meaning	Description
	Tag Group	Displays the grouped tags.
	Symbol Tag Group	Up to two levels of groups can be registered.
	Numeric Tag	Displays the tag in which the data type is the symbol including 16-bit (Signed), 32-bit (Hex), single precision floating point, or the device address.
	Bit Tag	Displays the tag in which the data type is the bit symbol, or the device address.
abc	Character String Tag	Displays the tag in which the data type is the character string symbol, or the device address.

NOTE

- In the tree view, GP4000/LT4000 Series nodes are listed under [GP4000 Series] and GP3000 Series nodes and LT3000 nodes are listed under [GP3000 Series].
- A tag with an error is displayed with the -attached icon on the Station Explorer.

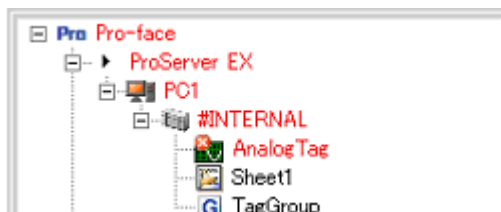

7 ItemID View

The ItemID View displays in a tree how the registered tags are shown as the ItemID on the OPC Server. The nodes, Device/PLCs, and tag groups are displayed as branches.

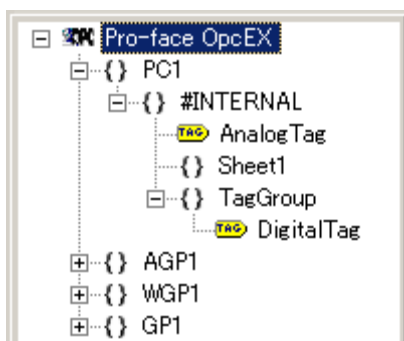

8 Display of Disabled Tags

A disabled tag is displayed with the  -attached icon on the Station Explorer. The disabled tags are not displayed on the ItemID View.

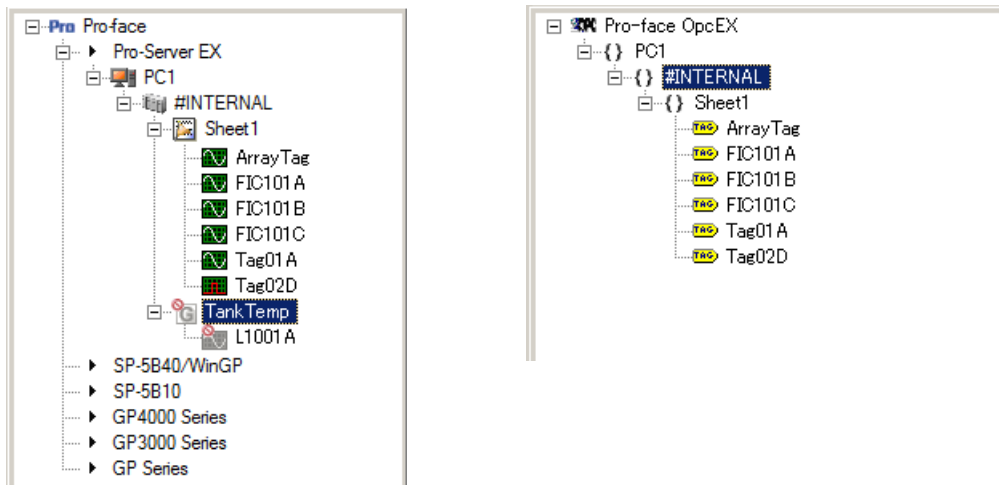

9 Tag Parameter View

The tag parameter is displayed in the tag parameter view. Displayed contents depend on the item selected on the Station Explorer or ItemID View.

Selected Item	Displayed Contents
Device/PLC	Displays the parameters of the tag registered directly under the Device/PLC. The tag group or tag under the group is not displayed.
Tag Group	Displays the parameters of the tag under the selected tag group.
Tag	Displays the parameters of the selected tag.
Others	Displays none.

In addition, only the following parameters that are common among each data type of Numeric, Bit, and Character String are displayed.

The parameters depending on the data type including the signal condition or open label are not displayed.

Parameters	Description
ItemID	Displays the tag as the ItemID on the OPC Server
Tag	Tag name for the symbol or device address
Device Address	Symbol name or device address
Data Type	Data type of the symbol or device address 16-bit (Signed, Unsigned, HEX, BCD) 32-bit (Signed, Unsigned, HEX, BCD) Bit, Single precision floating point, Double precision floating point, Character string
Description	Tag description

10 Error List









Displays the list of tags with errors. Double-click a tag on the list to move to the corresponding tag on the Station Explorer.

11 Tag Search Result

Displays a list of tags hit in the tag search. Double-click a tag on the list to move to the corresponding tag on the Station Explorer.

2.3.2 Menu Bar

The menu configuration is shown below. Refer to "4 Menu Configuration of the Configuration Tool" for more details.

Menu		Description
File		
	New	Creates a file of the same status as when the Configuration Tool is started (only the node configuration of NPX is displayed, no tag is registered).
	Open	Displays the [Open] dialog box and opens the selected configuration file.
	Save	Saves the currently open configuration information in a file.
-	Save As	Displays the [Save as] dialog box and saves the configuration information under a specified file name.
-	Exit	Exits the Configuration Tool.
Edit		
	Delete	Deletes a selected tag or tag group.
-	Rename	Changes the name of a selected tag or tag group.
-	Modify Tag	Edits the existing tag.
	Add Tag Group	Adds a tag group.
	Add Tag	Adds a tag.
	Find Tag	Searches for a specified tag.
-	NPX Symbol Import	Collectively imports the symbols registered in 'Pro-Server EX'.
View		
-	Station Explorer	Switches the display to the Station Explorer.
-	ItemID View	Switches the display to the ItemID View.
-	Error List	Switches the display to the Error List.
-	Tag Search Result	Switches the display to the Tag Search Result.
OPC Server		
-	Shutdown	Shuts down the OPC Server.
-	OPC Server Configuration Settings	Sets the OPC Server configuration.
-	Scan Cycle List Settings	Sets the scan cycle list.
Tool		
-	Option	Sets the default tag parameter.
Help		
	Reference Manual	Displays the Reference Manual (this book).
-	About Version	Displays the version information of the 'OPC Server for Pro-Server EX'.

2.4 Registering a Tag

Register the symbol variables or Device/PLCs registered in 'Pro-Server EX' as the tags.

To register the symbol → "2.4.1 Tag Registering a Symbol"

To register the Device/PLC → "2.4.2 Tag Registering a Device Address"

2.4.1 Tag Registering a Symbol

- 1 On the Station Explorer, select the symbol sheet in which the symbol you want to tag is registered, and select [Add Tag] from the [Edit] menu.

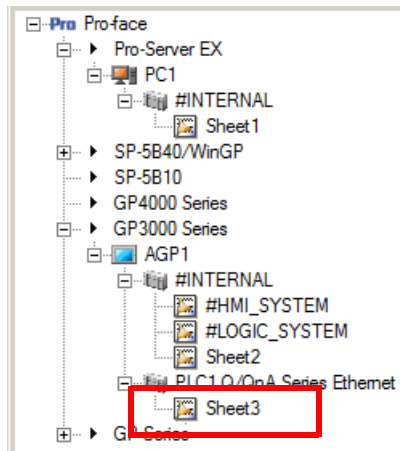

NOTE

- You can also use the [Add Tag] icon  on the Tool Bar.

2 Click [Symbol Icon], and select the symbol you want to register from the displayed symbol tree.

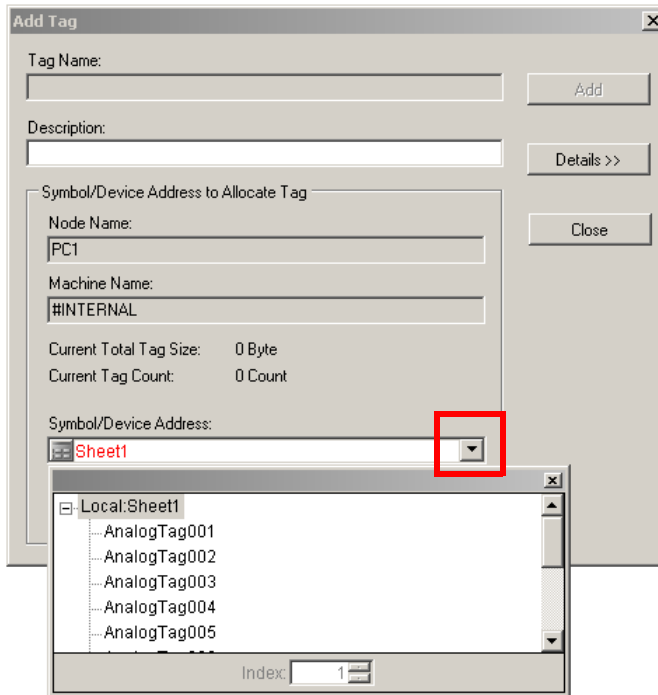

NOTE • The data type or data count of the selected symbol is set under [Data Type] and [Data Count]. The symbol name is set under [Tag Name], and the symbol comment is set under [Description].

3 Click [Add] to display the added tag on the Station Explorer.
To add another tag, register it using the same procedure above.

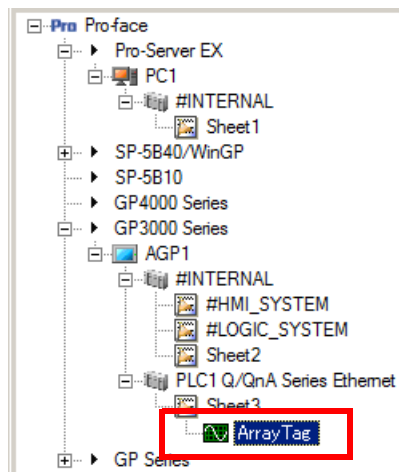

4 To finish the tag registration, click [Close] to close the [Add Tag] dialog box.

2.4.2 Tag Registering a Device Address

- 1 On the Station Explorer, select the Device/PLC with the device address you want to tag, and select [Add Tag] from the [Edit] menu.

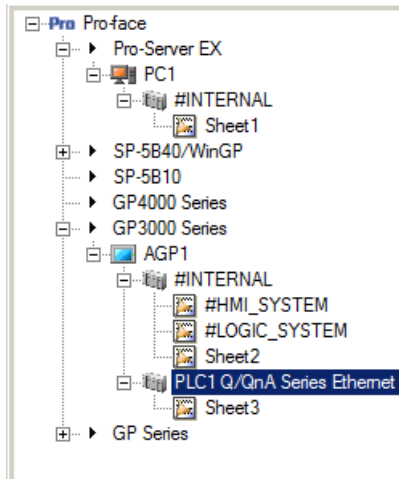

NOTE • You can also use the [Add Tag] icon  on the Tool Bar.

- 2 Directly enter the device address to register under [Symbol/Device Address].

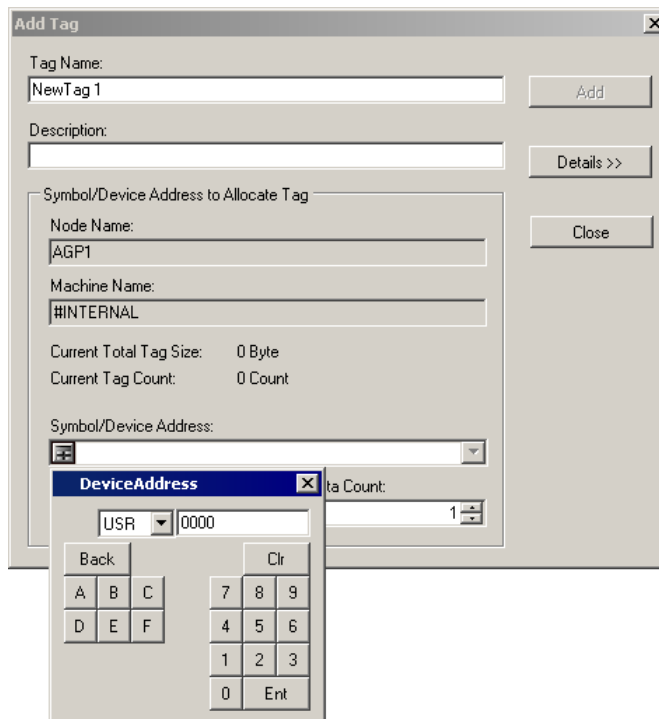

- 3 Set the device data type under [Data Type] and the device data count under [Device Count].

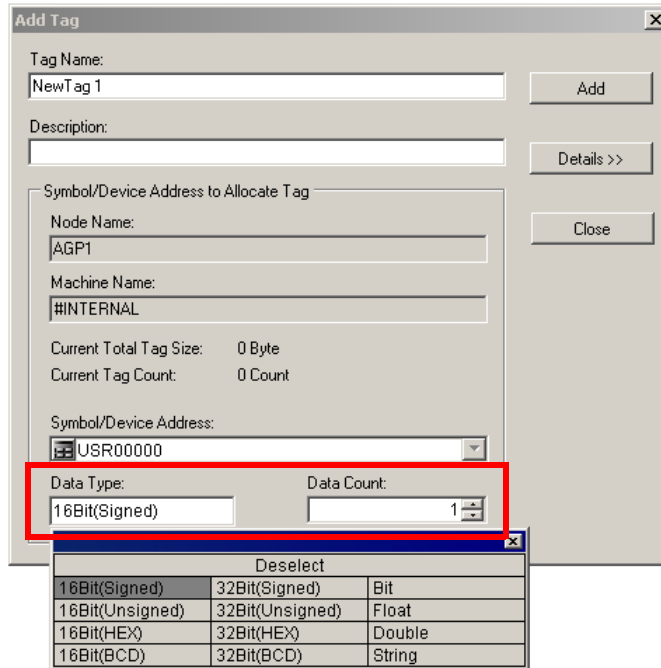

- 4 Enter the device tag name under [Tag Name] and the additional tag description under [Description], and then click [Add].

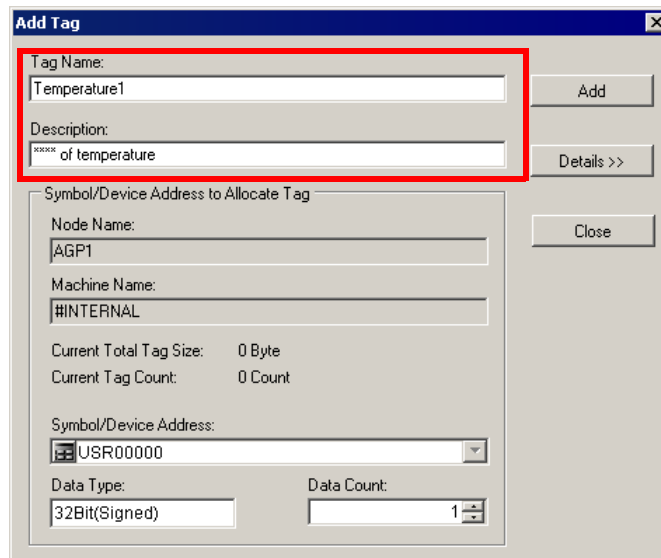

5 The additional tag is displayed on the Station Explorer.

To add another tag, register it using the same procedure above.

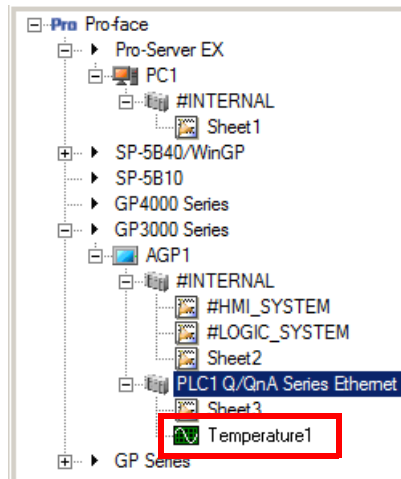

6 To finish the tag registration, click [Close] to close the [Add Tag] dialog box.

2.4.3 Registering Detailed Tag Parameters

- 1 Click the [Details <<] button to display the detailed tag parameters.

The screenshot shows the 'Add Tag' dialog box with the following fields and values:

- Tag Name: NewTag 1
- Description: (empty)
- Node Name: PC1
- Machine Name: #INTERNAL
- Current Total Tag Size: 2 Byte
- Current Tag Count: 1 Count
- Symbol/Device Address: (empty)
- Data Type: 16Bit(Signed)
- Data Count: 1

The detailed parameters table is highlighted with a red box:

Parameter	Value
Signal Condition	None
Low Instrument Range	0
High Instrument Range	100
Low EU	0
High EU	100
Decimal Point	0
Engineering Unit	%
Dead Band	0
Simulation	None

NOTE

- The detailed parameter items depend on the contents set in [Data Type]. Refer to "2.5.1 Detailed Tag Parameters" for more details.
- The default detailed parameters are the values set under [Option] in the [Tool] menu.

2 You can change the corresponding parameter contents.

NOTE • To set [Scan Cycle], click the parameter area and select from the dropdown list.

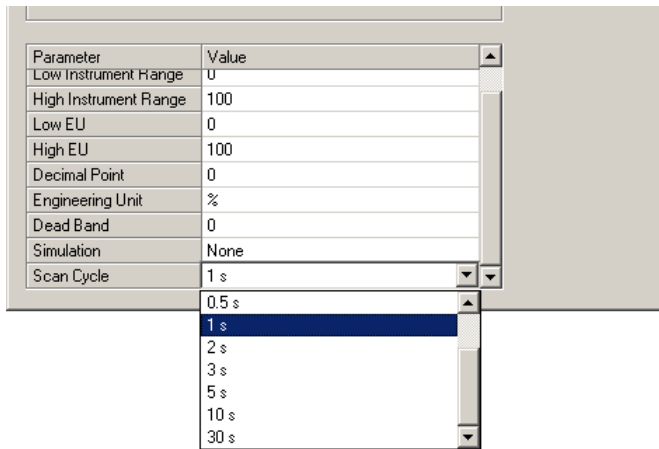

2.5 Confirming the Detailed Specification

2.5.1 Detailed Tag Parameters

The detailed tag parameters available to set per data type are shown below.

Data Type	Parameters	Setting Range	Default
16-bit (Signed) 16-bit (Unsigned) 16-bit (HEX) 16-bit (BCD)	Signal Condition	Depends on the data type. Refer to "2.5.2 Signal Condition" for more details.	None
32-bit (Signed) 32-bit (Unsigned) 32-bit (HEX) 32-bit (BCD)	Low Instrument Range	Depends on the data type and signal condition. Refer to "2.5.3 Lower Input-Range Limit and Upper Input-Range Limit" for more details.	0
	High Instrument Range		100
Single-precision floating point Double-precision floating point	Low EU	-1.7976931348623157E+308 to High EU	0
	High EU	Low EU to 1.7976931348623157E+308	100
	Decimal Point	0 to 7	0
	Engineering Unit	0 to 16 characters	%
	Dead Band	0 to 100 (%)	0
Double-precision floating point	Simulation	None, Increment, Random, SIN, COS, CSV	None
	Scan Cycle	Select from the scan cycle list.	1 s
	Bit	Inverse	Inverted if checked
Open Label		0 to 16 characters	Blank character
Close Label		0 to 16 characters	Blank character
Simulation		None, CSV	None
Scan Cycle		Select from the scan cycle list.	1 s
Character String	NULL Termination	NULL Termination if checked	Not checked
	Simulation	None, CSV	None
	Scan Cycle	Select from the scan cycle list.	1 s

2.5.2 Signal Condition

The signal conditions available to set per data type are shown below.

Data Type	Signal Condition Available to Set
16-bit (Signed)	None, 8Bit Binary, 12Bit Binary, 13Bit Binary, 15Bit Binary, 3BCD, 4BCD, Linear, SQRT
16-bit (Unsigned)	
16-bit (HEX)	
16-bit (BCD)	None
32-bit (Signed)	None, Linear, SQRT, BCD
32-bit (Unsigned)	
32-bit (HEX)	
32-bit (BCD)	None
Single-precision floating point	None, Linear, SQRT
Double-precision floating point	None, Linear, SQRT

- Actual Count Process (None)

For a tag in which the signal condition is None and the decimal point is not zero, the entered data is assumed as the fixed decimal point, and the tag is divided by the specified decimal point. Nothing is processed for other tags.

$$\text{OPC Read (Engineering Unit)} = x / 10^P$$

$$\text{OPC Write (Reverse Conversion)} = x * 10^P$$

x: Entered Value

P: Decimal-Point Position

- Linearize (Linear)

Evaluate the linearized conversion by the following conversion formulae.

$$\text{OPC Read (Engineering Unit)} = (x - \text{RawL}) * (\text{ScaledH} - \text{ScaledL}) / (\text{RawH} - \text{RawL}) + \text{ScaledL}$$

$$\text{OPC Write (Reverse Conversion)} = (x - \text{ScaledL}) * (\text{RowH} - \text{RowL}) / (\text{ScaledH} - \text{ScaledL}) + \text{RowL}$$

x: Entered Value

RawL: Upper Input-Range Limit

RawH: Lower Input-Range Limit

ScaledH: Upper Instrument-Range Limit

ScaledL: Lower Instrument-Range Limit

- Square Root (SQRT)

Evaluate the square root conversion using the following conversion formulae:

$$\text{OPC Read (Engineering Unit)} = \text{sqrt}((x - \text{RawL}) * ((\text{ScaledH} - \text{ScaledL}) / \text{sqrt}((\text{RawH} - \text{RawL}))) + \text{ScaledL})$$

$$\text{OPC Write (Reverse Conversion)} = (x - \text{ScaledL})^2 * ((\text{RowH} - \text{RowL}) / (\text{ScaledH} - \text{ScaledL})^2) + \text{RowL}$$

x: Entered Value

RawL: Upper Input-Range Limit

RawH: Lower Input-Range Limit

ScaledH: Upper Instrument-Range Limit

ScaledL: Lower Instrument-Range Limit

2.5.3 Lower Input-Range Limit and Upper Input-Range Limit

The setting ranges of [Lower Input-Range Limit] and [Upper Input-Range Limit] for each combination of the data type and signal condition are shown below.

Data Type	Signal Condition	Setting Range	
		Lower Limit	Upper Limit
16-bit (Signed)	None	-32768 to Upper Limit	Lower Limit to 32767
	8Bit Binary	-128 to Upper Limit	Lower Limit to 127
	12Bit Binary	-2048 to Upper Limit	Lower Limit to 2047
	13Bit Binary	-4096 to Upper Limit	Lower Limit to 4095
	15Bit Binary	-16384 to Upper Limit	Lower Limit to 16383
	3BCD	0 to Upper Limit	Lower Limit to 999
	4BCD	0 to Upper Limit	Lower Limit to 9999
	Linear	-32768 to Upper Limit	Lower Limit to 32767
	SQRT	-32768 to Upper Limit	Lower Limit to 32767
16-bit (Unsigned) 16-bit (HEX)	None	0 to Upper Limit	Lower Limit to 65535
	8Bit Binary	0 to Upper Limit	Lower Limit to 255
	12Bit Binary	0 to Upper Limit	Lower Limit to 4095
	13Bit Binary	0 to Upper Limit	Lower Limit to 8191
	15Bit Binary	0 to Upper Limit	Lower Limit to 32767
	3BCD	0 to Upper Limit	Lower Limit to 999
	4BCD	0 to Upper Limit	Lower Limit to 9999
	Linear	0 to Upper Limit	Lower Limit to 65535
	SQRT	0 to Upper Limit	Lower Limit to 65535
16-bit (BCD)	None	0 to Upper Limit	Lower Limit to 9999
32-bit (Signed)	None	-2147483648 to Upper Limit	Lower Limit to 2147483647
	Linear	-2147483648 to Upper Limit	Lower Limit to 2147483647
	SQRT	-2147483648 to Upper Limit	Lower Limit to 2147483647
	BCD	0 to Upper Limit	Lower Limit to 99999999
32-bit (Unsigned) 32-bit (HEX)	None	0 to Upper Limit	Lower Limit to 4294967295
	Linear	0 to Upper Limit	Lower Limit to 4294967295
	SQRT	0 to Upper Limit	Lower Limit to 4294967295
	BCD	0 to Upper Limit	Lower Limit to 99999999
32-bit (BCD)	None	0 to Upper Limit	Lower Limit to 99999999
Single-precision floating point	None	-3.402823466E+38 to Upper Limit	Lower Limit to 3.402823466E+38
	Linear	-3.402823466E+38 to Upper Limit	Lower Limit to 3.402823466E+38
	SQRT	-3.402823466E+38 to Upper Limit	Lower Limit to 3.402823466E+38

Data Type	Signal Condition	Setting Range	
		Lower Limit	Upper Limit
Double-precision floating point	None	-1.7976931348623157E+308 to Upper Limit	Lower Limit to 1.7976931348623157E+308
	Linear	-1.7976931348623157E+308 to Upper Limit	Lower Limit to 1.7976931348623157E+308
	SQRT	-1.7976931348623157E+308 to Upper Limit	Lower Limit to 1.7976931348623157E+308

2.5.4 Item Property ID

The list of the OPC Server item properties is shown below:

No.	Item Property	Property ID	Data Type	Description
1	Canonical DataType	1	-	Canonical Data Type
2	ItemValue	2	-	Device Item Value
3	ItemQuality	3	-	Item Quality
4	Timestamp	4	VT_DATE	Time Stamp
5	AccessRights	5	VT_I4	Access rights
6	ScanRate	6	VT_R4	Scan rate
7	Node	5000	VT_BSTR	Node
8	Name	5001	VT_BSTR	Tag Name Character string of 1 to 40 characters
9	SheetName	5002	VT_BSTR	Sheet Name Character string of 1 to 32 characters
10	SymbolName	5003	VT_BSTR	Symbol Name Character string of 1 to 32 characters
11	DeviceVariableName	5004	VT_BSTR	Device Name Character String
12	DataType	5005	VT_BSTR	Input Data Type
13	DataCount	5006	VT_I4	Data Count 1 to 1020
14	EngineeringUnit	100	VT_BSTR	Engineering Unit Character string of 0 to 16 characters
15	Description	101	VT_BSTR	Tag Name Description Character string of 0 to 256 characters
16	HighEU	102	VT_R8	Upper Instrument-Range Limit
17	LowEU	103	VT_R8	Lower Instrument-Range Limit
18	HighInstrumentRange	104	VT_R8	Upper Input-Range Limit
19	LowInstrumentRange	105	VT_R8	Lower Input-Range Limit
20	CloseLabel	106	VT_BSTR	Close Label
21	OpenLabel	107	VT_BSTR	Open Label
22	DeadBand	306	VT_R8	Dead Band 0.0 to 100.0
23	DecimalPoint	5007	VT_I4	Decimal Point 0 to 7
24	Inverse	5008	VT_BSTR	Status Inversion

No.	Item Property	Property ID	Data Type	Description	
25	SignalCondition	5009	VT_BSTR	All Data Types	None
				16-bit	8Bit Binary, 12Bit Binary, 13Bit Binary, 15Bit Binary, Linear, SQRT, 3BCD, 4BCD
				32-bit	Linear, SQRT, BCD
26	NullTermination	5010	VT_BOOL	NULL Termination	
27	Simulation	5011	VT_BSTR	None, Increment, Random, SIN, COS, CSV	

2.6 Environment Setting When Operating OPC Server and OPC Client on Different PCs

"DCOM Setting" is required to remotely connect to the OPC Server or OPC Client.

For this reason, you need to change the security settings for DCOM on a PC with the OPC Server or the OPC Client already running.

IMPORTANT • To change the security settings, log on as a user with "Administrator's rights".

NOTE • When running the OPC server and client on different PCs, use a common account.
• Depending on the operating system you are using, the display and part names may differ. If so, replace the names with those with similar features used in your system configuration.

2.6.1 Changing the "Local Security Policy"

- 1 Open [Administrative Tools] under [Control Panel], and run [Local Security Policy].

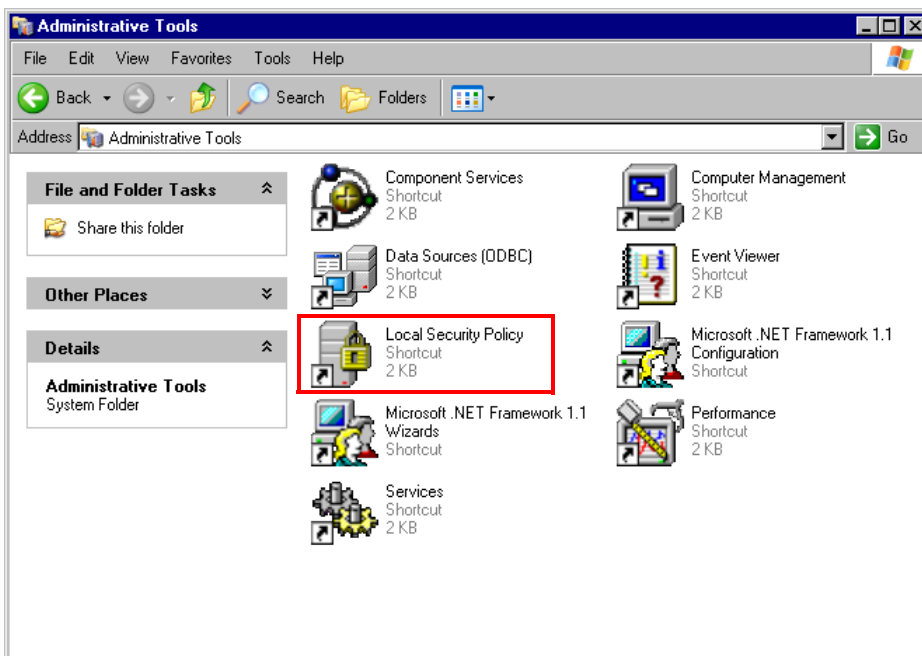

2 Select [Security Options] under [Local Policies], and double-click [Accounts: Limit local account use of blank passwords to console logon only].

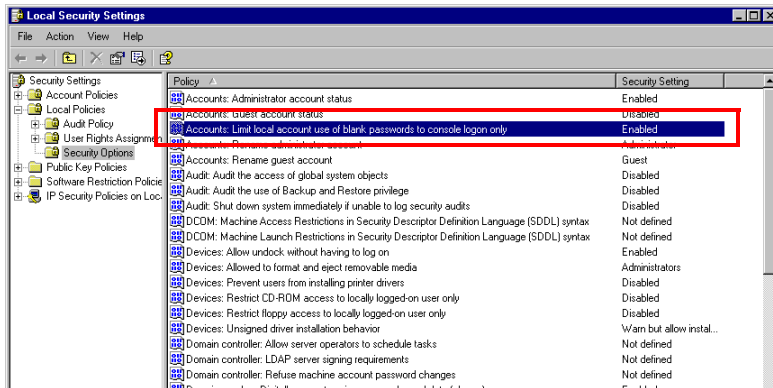

3 Select [Disabled] and click [OK].

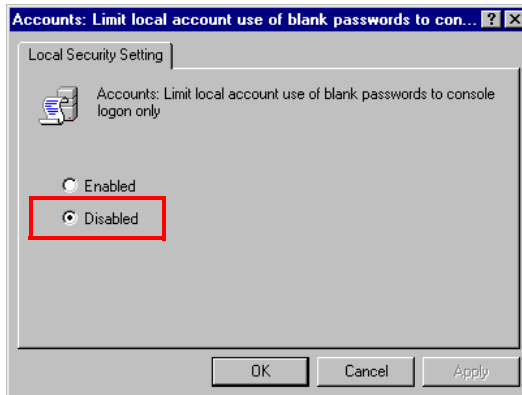

4 Similarly, double-click [Network access: Sharing and security model for local accounts].

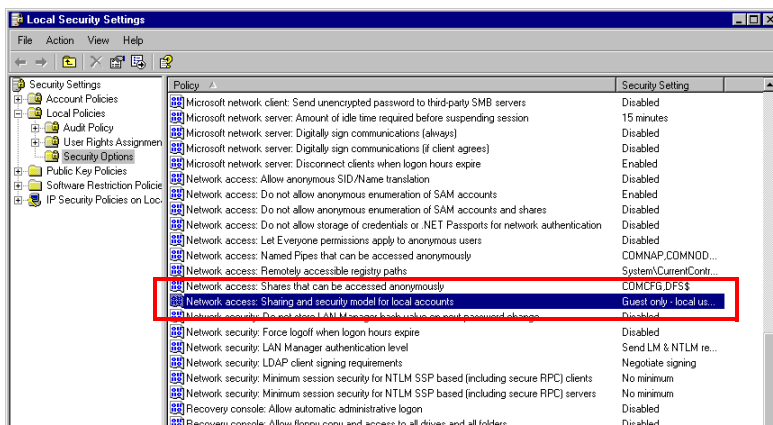

5 Select [Classic - local users authenticate as themselves] and click [OK].

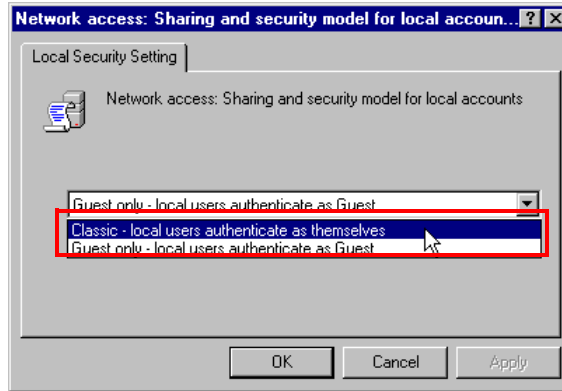

6 Similarly, double-click [Network access: Allow anonymous SID/Name translation].

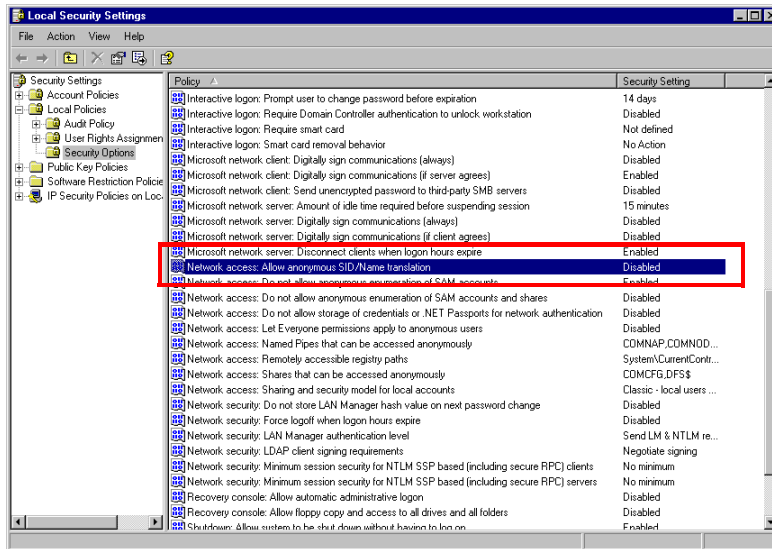

7 Select [Enabled] and click [OK].

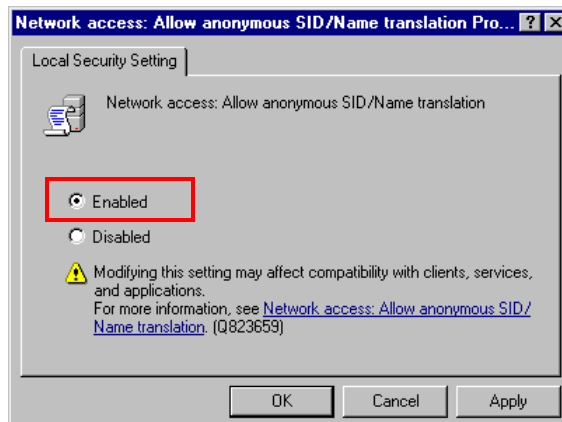

2.6.2 Setting Windows Firewall

Microsoft and the OPC-Foundation recommend the Windows Firewall setting remain [On] to protect the PC. If you set Windows Firewall to [ON] and use the OPC Server or OPC Client, the following settings are required:

- NOTE** • Depending on the operating system you are using, the display and part names may differ. If so, replace the names with those with similar features used in your system configuration.

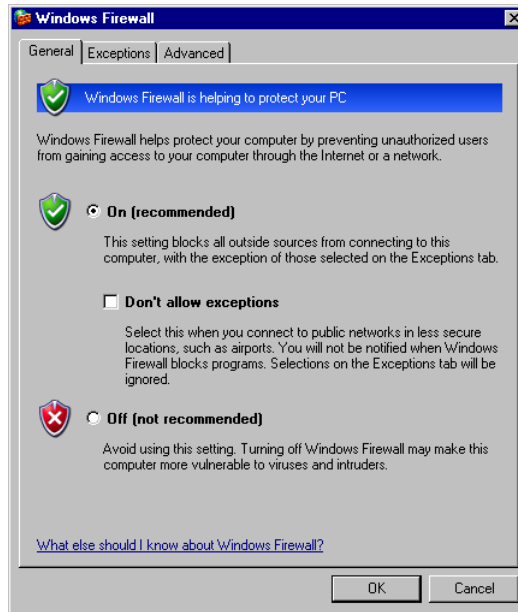

- 1 Select the [Exceptions] tab under [Windows Firewall] from the [Control Panel], and click [Add Program].

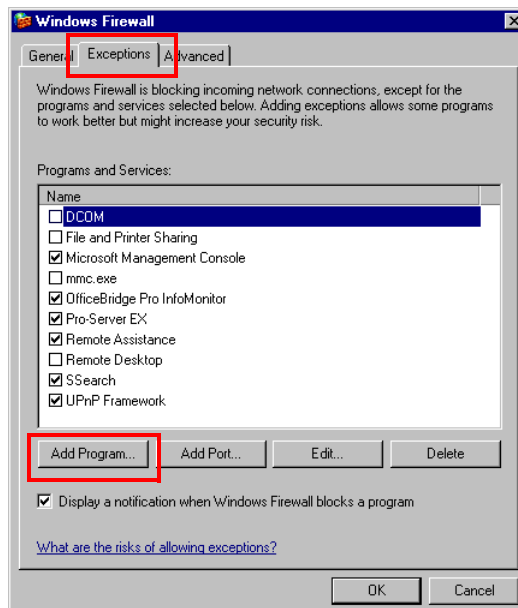

2 Click [Browse] and add the programs. The programs to be added differ between the server and the clients' PCs. Refer to the following and add the appropriate programs, respectively.

- Server PC
 - C:\Windows\System32\mmc.exe
 - C:\Windows\System32\OpcEnum.exe
 - C:\Program Files\Pro-face\OPC Server for Pro-Server EX\OPC DA ProServer.exe
(On Windows Vista or later, "C:\Pro-face\OPC Server for Pro-Server EX\OPC DA ProServer.exe")
- Client PC
 - C:\Windows\System32\mmc.exe
 - C:\Windows\System32\OpcEnum.exe
 - C:\Program Files\Pro-face\OPC Server for Pro-Server EX\Pro-faceOpcDaClient.exe
(On Windows Vista or later, "C:\Pro-face\OPC Server for Pro-Server EX\Pro-faceOpcDaClient.exe")

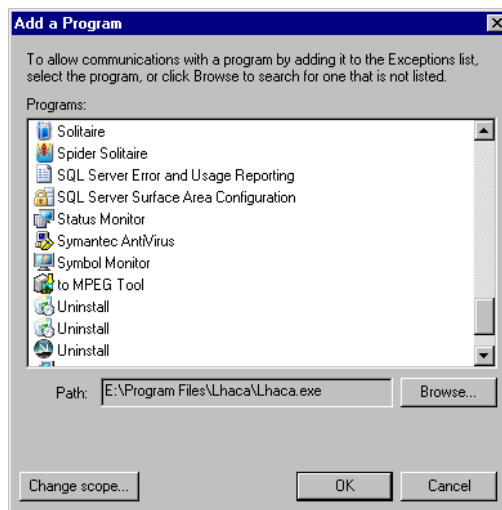

3 Next check the following options.

- File and Printer Sharing
- Network Search (Only when using Windows Vista)

4 Next check [Add Port].

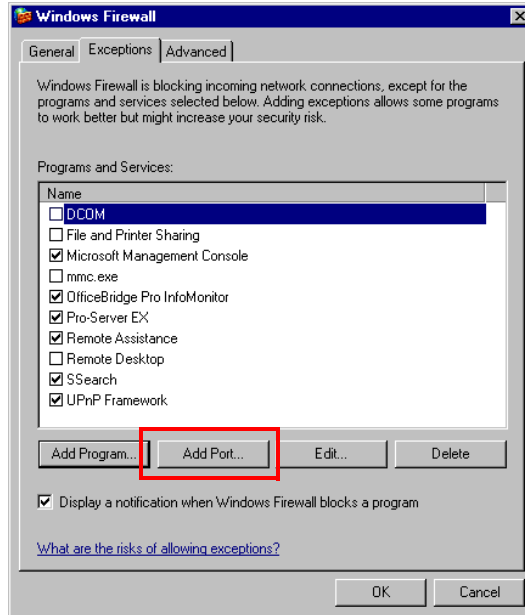

5 In the [Add a Port] dialog box, enter as "Name: DCOM", "Port Number: 135", and check "TCP".

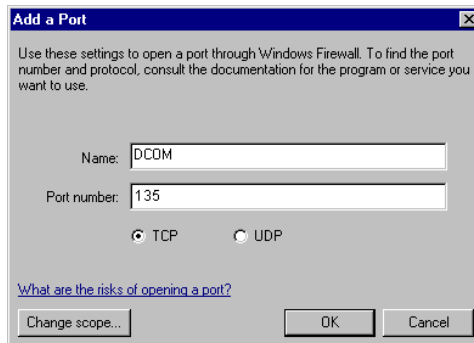

2.6.3 Setting DCOM on a PC with the OPC Server Running

To allow the OPC Client to remotely connect to the OPC Server using DCOM, you need to use the DCOMCNFG utility to configure the OPC Server settings after installation.

- NOTE**
- If you do not use DCOM (all OPC Clients on OPC Servers are located on the same PC), the setting with the DCOMCNFG utility is not necessary.
 - Depending on the operating system you are using, the display and part names may differ. If so, replace the names with those with similar features used in your system configuration.

1 To activate the DCOMCNFG utility, select [Run] from Windows start menu. Enter "dcomcnfg" and click [OK].

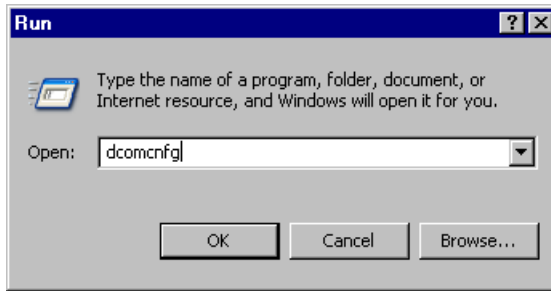

2 The component service screen is displayed. Select [Computers] under [Component Services], right-click on [My Computer], and select [Properties].

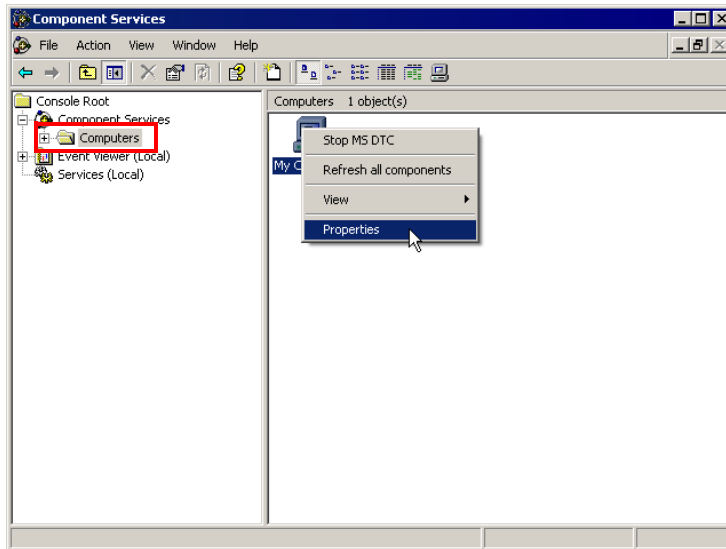

- The properties screen of "My Computer" is displayed. Select the [COM Security] tab and click [Edit Limits] on [Access Permissions].

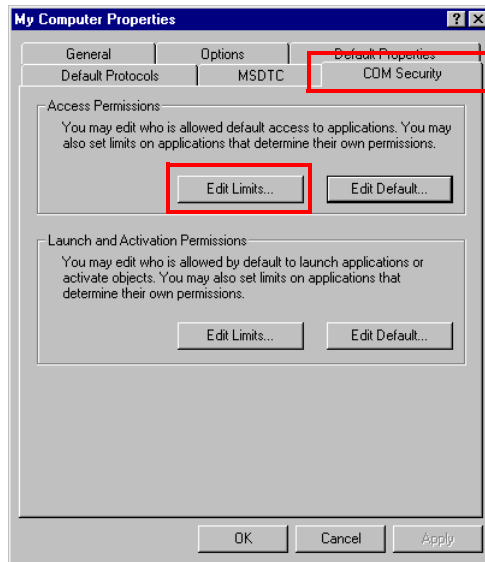

- The setting [Remote Access] should be denied for [ANONYMOUS LOGON] users. Also the setting [Remote Access] should be allowed for [Everyone] users.

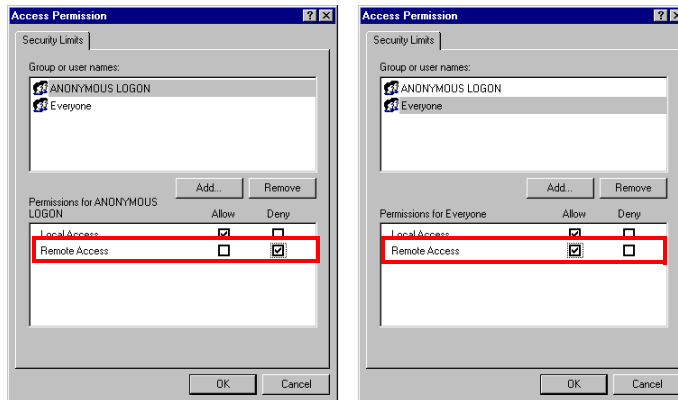

5 Click [Edit Default] on [Access Permissions], and set [Remote Access] to [Allow] for [Everyone] users.

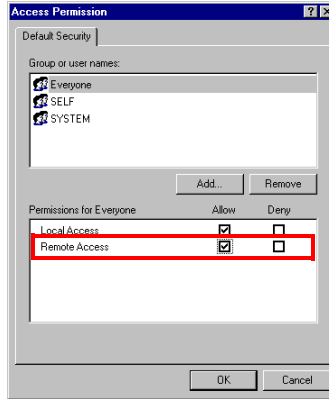

NOTE

- Depending on your system environment, "Everyone" may not be displayed. In this case, follow these steps to add "Everyone" users:
 - (1) Click [Add] on the [Access Permission] screen. The [Select Users or Groups] screen appears.
 - (2) Click [Object Types]. The [Object Types] screen appears.
 - (3) Make sure that "Built-in security principals" is checked, and then click [OK]. If it is not checked, click to add a checkmark. Clicking [OK] returns you to the [Select Users or Groups] screen.
 - (4) Click [Advanced]. The [Select Users or Groups] screen appears.
 - (5) Type "Everyone" in the [Common Queries] entry field.
 - (6) Click [Find Now]. "Everyone" appears in the lower part of the screen.
 - (7) Select "Everyone" in the lower part of the screen, and then click [OK]. This returns you to the [Select Users or Groups] screen.
 - (8) Click [OK] to add "Everyone" to the [Access Permission] screen.

6 Click [Edit Limits] on [Launch and Activation Permissions], and set [Remote Launch] and [Remote Activation] to [Allow] for [Administrators] and [Everyone] users.

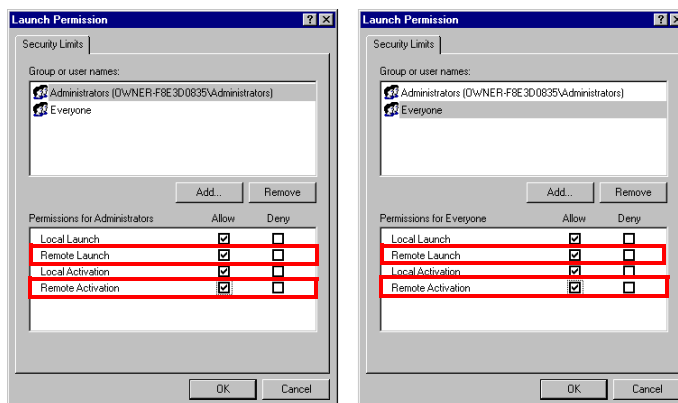

- Click [Edit Default] on [Launch and Activation Permissions], and set [Remote Launch] and [Remote Activation] to [Allow] for [Everyone] users.

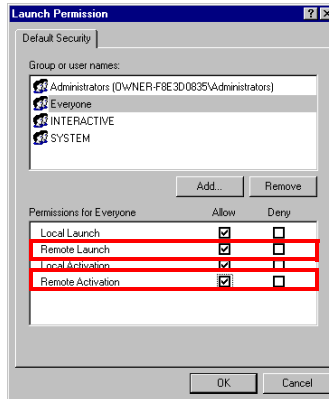

- Select [DCOM Config] under [My Computer].

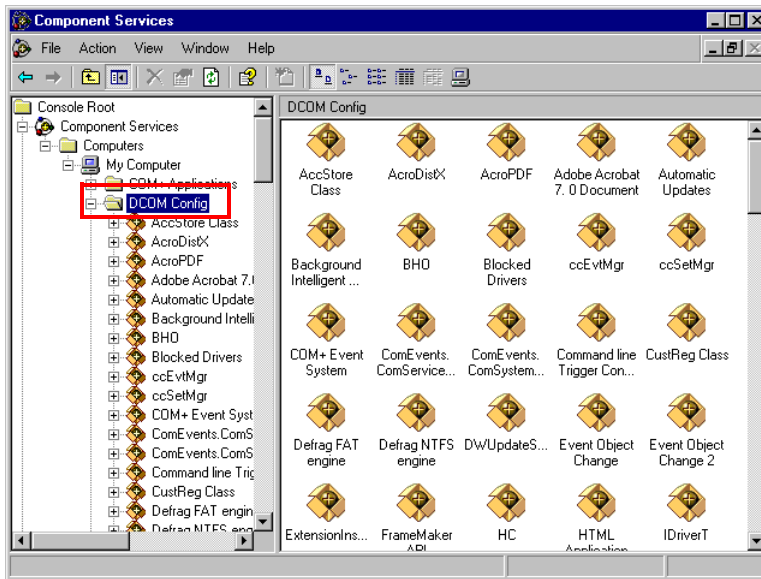

9 Right-click on [Pro-face OPCEX Data Access 2.05a/3.00 Service], and select the properties.

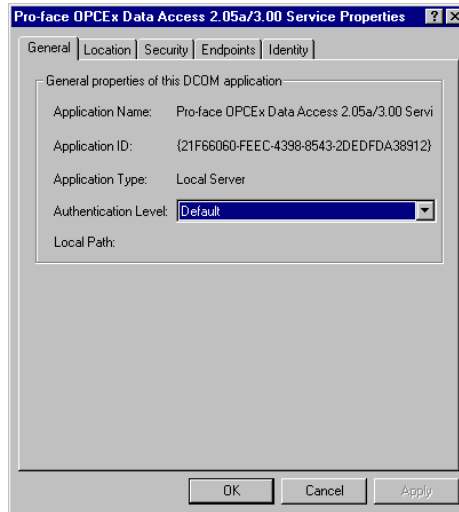

10 Click the [Identity] tab, select [The interactive user], and click [OK].

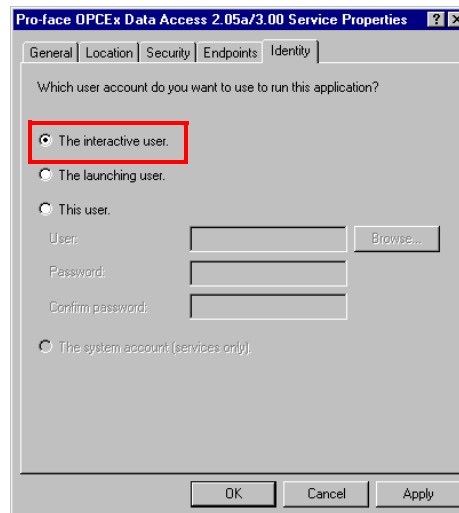

2.6.4 Setting DCOM on a PC with the OPC Client Running

To activate the Subscription (OnDataChange) for calling the OPC Client from the OPC Server, the DCOM setting is also required on a PC with the OPC Client already running.

-
- NOTE** • Depending on the operating system you are using, the display and part names may differ. If so, replace the names with those with similar features used in your system configuration.
-

- 1 To activate the DCOMCNFG utility, select [Run] from Windows start menu. Enter "dcomcnfg" and click [OK].

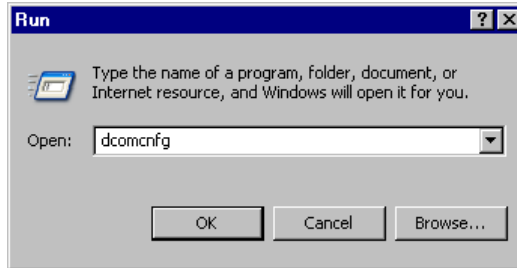

- 2 The component service screen is displayed. Select [Computers] under [Component Services], right-click on [My Computer], and select [Properties].

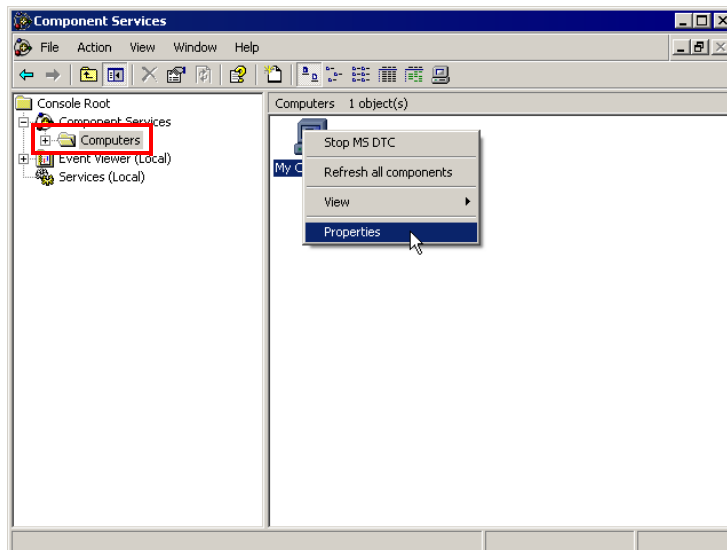

- The properties screen of "My Computer" is displayed. Select the [COM Security] tab and click [Edit Limits] on [Access Permissions].

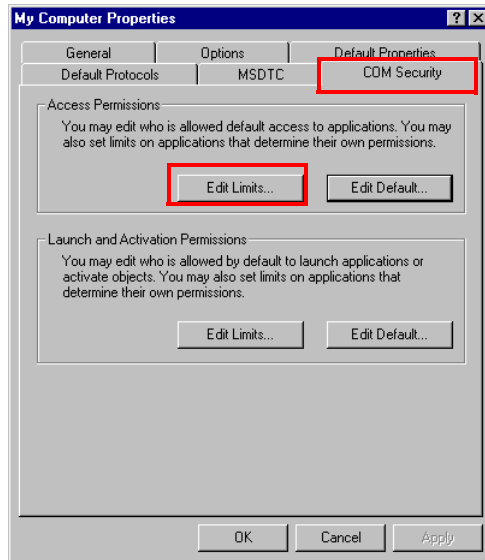

- Set [Remote Access] to [Allow] for [ANONYMOUS LOGON] and [Everyone] users.

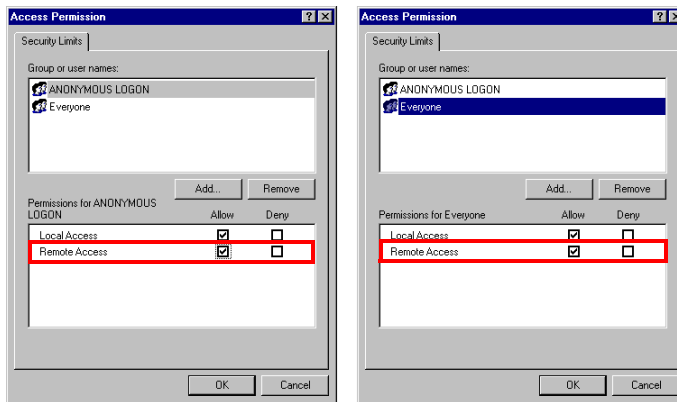

- NOTE** • Depending on your system environment, "Everyone" may not be displayed. In this case, follow these steps to add "Everyone" users:
- Click [Add] on the [Access Permission] screen. The [Select Users or Groups] screen appears.
 - Click [Object Types]. The [Object Types] screen appears.
 - Make sure that "Built-in security principals" is checked, and then click [OK]. If it is not checked, click to add a checkmark. Clicking [OK] returns you to the [Select Users or Groups] screen.
 - Click [Advanced]. The [Select Users or Groups] screen appears.
 - Type "Everyone" in the [Common Queries] entry field.
 - Click [Find Now]. "Everyone" appears in the lower part of the screen.
 - Select "Everyone" in the lower part of the screen, and then click [OK]. This returns you to the [Select Users or Groups] screen.
 - Click [OK] to add "Everyone" to the [Access Permission] screen.

- Click [Edit Default] on [Access Permissions]. The setting [Remote Access] should not be allowed for [SELF] and [SYSTEM] users. Also, the setting [Remote Access] should be allowed for [NETWORK] users.

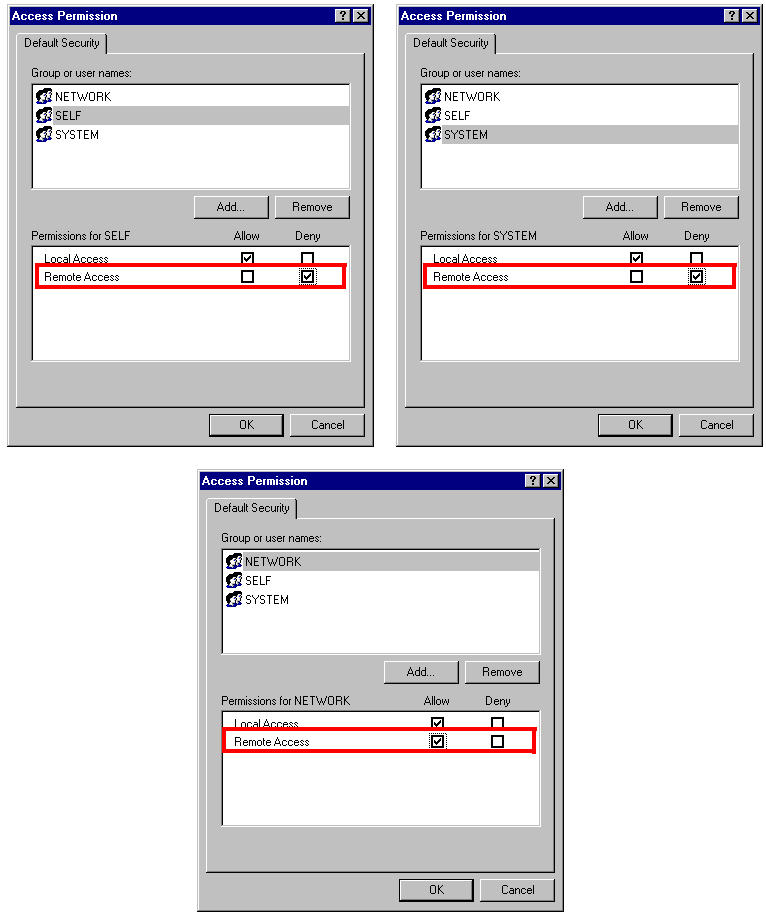

- Click [Edit Limits] on [Launch and Activation Permissions], and set [Remote Launch] and [Remote Activation] to [Allow] for [Administrators] and [Everyone] users.

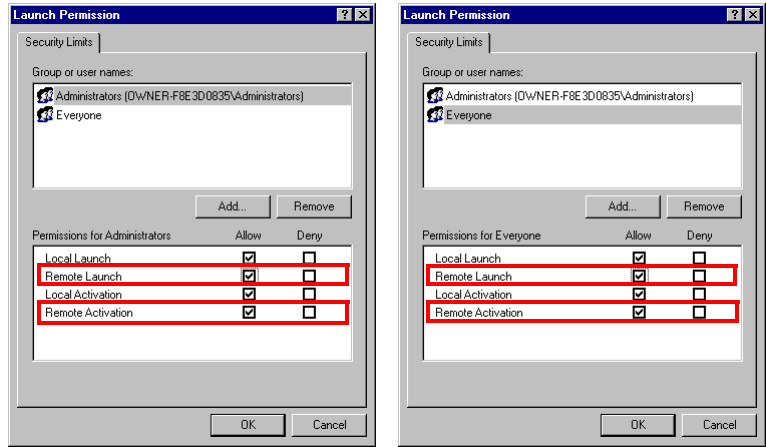

- 7 Click [Edit Default] on [Launch and Activation Permissions], and set [Remote Launch] and [Remote Activation] to [Allow] for [Everyone] and [Administrators] users. Also, the setting [Remote Access] and [Remote Activation] should not be allowed for [INTERACTIVE] or [SYSTEM] users.

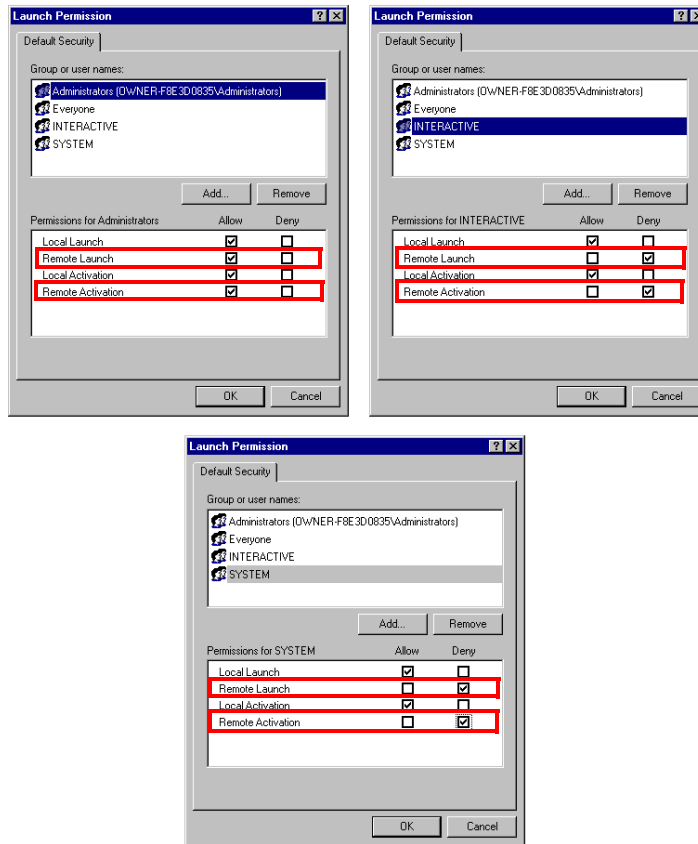

2.7 Operating the OPC Server as a Service

-
- IMPORTANT** • When installing 'OPC Server for Pro-Server EX', you need to check the option for "Install OPC Server for Pro-Server EX as a service".
-

- NOTE** • Depending on the operating system you are using, the display and part names may differ. If so, replace the names with those with similar features used in your system configuration
-

2.7.1 Environment Settings When Operating the OPC Server as a Service

Configure the following settings before operating the OPC Server as Windows Service. Otherwise, you cannot connect from the OPC Client to the OPC Server.

- 1 From the [Start] menu, select [Control Panel]-[Administrative Tools]-[Component Services] and open the following dialog box.

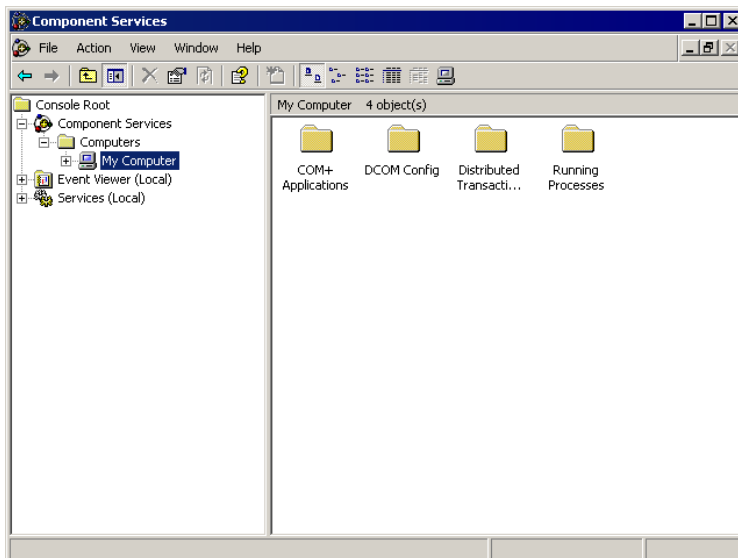

2 Right-click on [My Computer] and select [Properties].

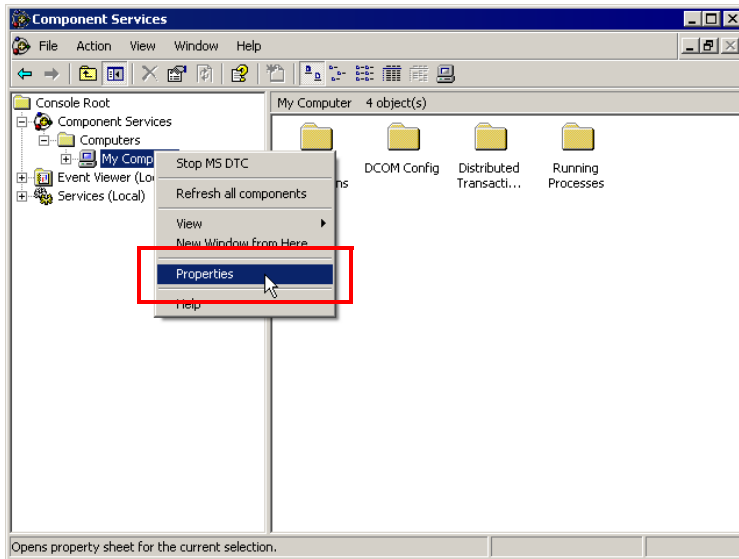

3 Select the [COM Security] tab and click [Edit Default] on [Access Permissions]. (Depending on your OS, you should click [Default Access Permissions] on the [Default Security] tab.)

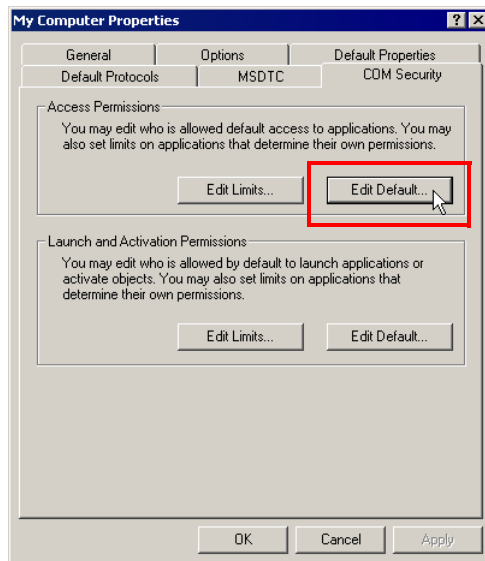

- 4 Select a login user who intends to use the OPC Client ("NETWORK" or "Everyone" for the remote connection) and register it using the [Add] button.

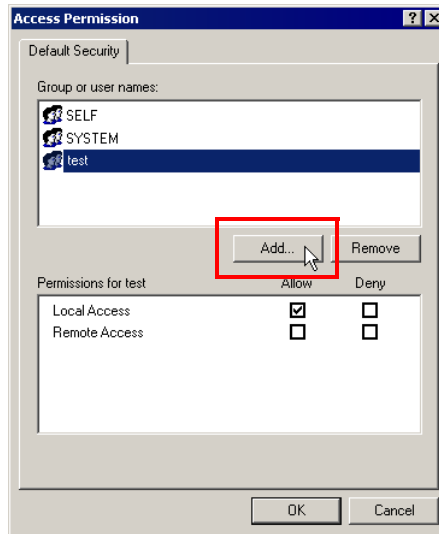

- 5 Check [Allow] for [Local Access] and click the [OK] button. (Depending on your OS, specify [Allow Default Access Permission] for [Type of Access].)

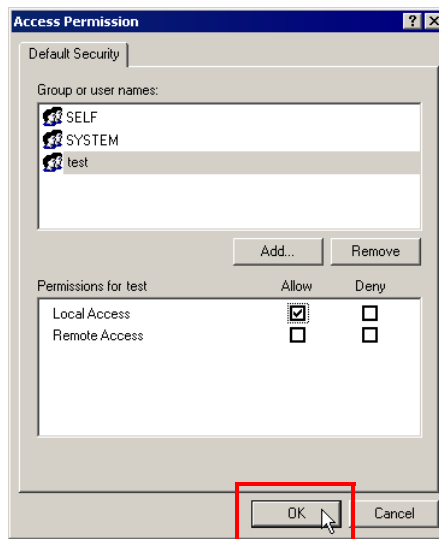

2.7.2 Using 'Pro-Server EX' for Setting

- 1 From the Start menu, select [Pro-face] - [Pro-Server EX] - [Pro-Server EX Environmental Setting]. The [Pro-Server EX Environment Settings] screen appears.
- 2 Check "Start Pro-Server EX as a service", and then click [OK].

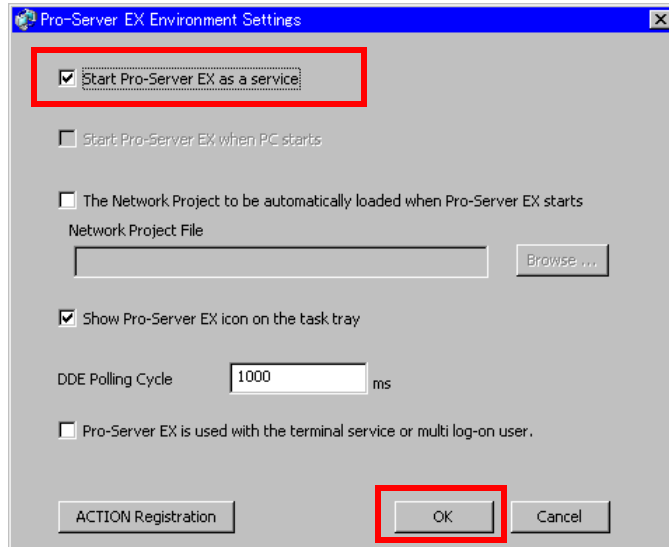

NOTE • If 'Pro-Server EX' is already running, restart 'Pro-Server EX' after the setting is completed.

- 3 Create NPX using 'Pro-Studio EX' and load it to 'Pro-Server EX'.
You might want to set NPX to be automatically loaded as needed. For the setting method, refer to "Pro-Server EX Reference Manual".

2.7.3 Using 'OPC Server for Pro-Server EX' for Setting

1 From the Start menu, select [Pro-face] - [OPC Server for Pro-Server EX] - [OPC Server Configuration Tool for Pro-Server EX] to start the Configuration Tool.

Here, you register a tag. For the registration method, refer to "2.4 Registering a Tag".

2 Click the [Save] icon to save the result as a tag configuration file.

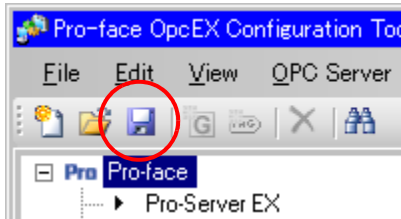

3 Select [OPC Server Configuration Settings] from the [OPC Server] menu, and apply the saved tag configuration file to the OPC Server.

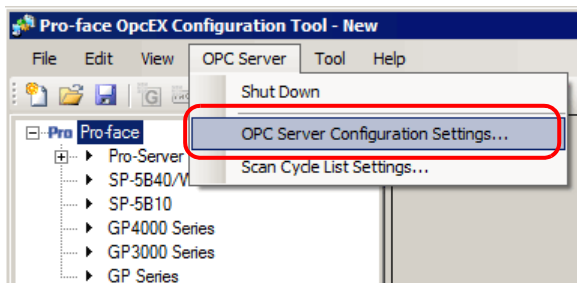

4 Click [...], select the tag configuration file saved in step 2, and then click [OK].

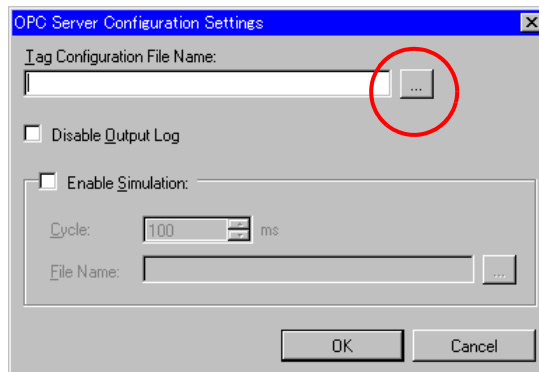

5 From the [OPC Server] menu, select [Shut Down] to shut down the OPC Server. The configuration information is applied to the OPC Server. (When the OPC Client connects to the OPC Server, the OPC Server restarts.)

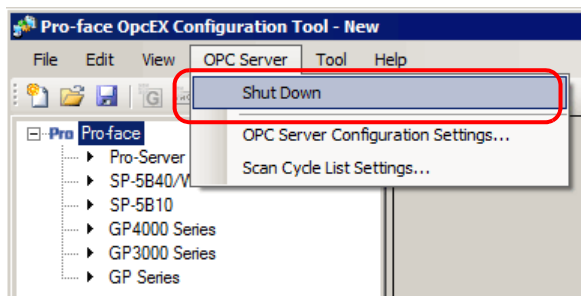

2.7.4 Connecting 'OPC Client for Pro-Server EX' to 'OPC Server for Pro-Server EX'

- 1 From the Start menu, select [Pro-face] - [OPC Server for Pro-Server EX] - [OPC Client for Pro-Server EX] to start the OPC Client.
- 2 From the [Server] selection drop-down list, select "opcda://localhost/Pro-face.OPCEX.1" to specify 'OPC Server for Pro-Server EX' on the local PC.

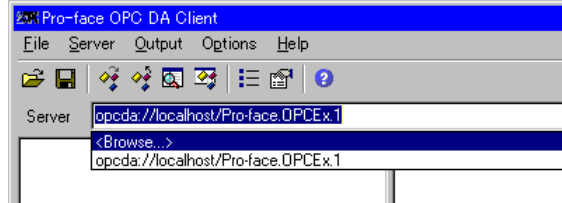

2.7.5 Notes on Operating the OPC Server as a Service

Note the following when operating the OPC Server as a server:

- To operate the OPC Server as a service, you need to specify the appropriate setting during installation. If 'OPC Server for Pro-Server EX' is already installed without "Install OPC Server for Pro-Server EX as a service" checked, reinstall it.
- 'OPC Server for Pro-Server EX' does not start automatically during Windows startup, even after it is installed. To make 'OPC Server for Pro-Server EX' start automatically during Windows startup, select [Control Panel] - [Administrative Tools] - [Services] - "Pro-face OPCEX DataAccess 2.05a/3.00 Service", and then specify "Automatic" for [Startup type].
- If you set 'OPC Server for Pro-Server EX' to start automatically during Windows startup, set it as well to automatically load a network project file to 'Pro-Server EX'. Check "The Network Project to be automatically loaded when Pro-Server EX starts" on the [Pro-Server EX Environment Settings] screen, and select the network project file you want to load.
- Depending on the operating system you are using, there are cases where the OPC client cannot access the local PC. On your desktop, right-click the "OPC Server Configuration Tool for Pro-Server EX" shortcut and set up to [Run As Administrator].

3



Operating the OPC DA Client

3.1	Starting the OPC Client	3-2
3.2	Connecting to and Disconnecting from the OPC Server	3-5
3.3	Synchronously Reading/Writing Item Data	3-8
3.4	Asynchronously Reading/Writing Item Data	3-17
3.5	Canceling and Restarting the Subscription Data Distribution	3-28
3.6	Editing and Deleting Items	3-30
3.7	Asynchronously Reading/Writing Item Data in the Group	3-32
3.8	Synchronous Processing Group Items	3-39
3.9	Browsing OPC Server Items	3-44

3 Operating the OPC DA Client

3.1 Starting the OPC Client

The OPC Client accesses the OPC Server to read or write the item data on the OPC Server based on the OPC DA specifications.

To start the OPC Client, select [Pro-face]-[OPC Server for Pro-Server EX]-[OPC Client for Pro-Server EX] from the start menu.

NOTE

- You can also double-click on the "OPC Client for Pro-Server EX" shortcut on the desktop.
 - Depending on the operating system you are using, the display and part names may differ. If so, replace the names with those with similar features used in your system configuration.
-

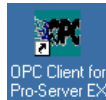

3.1.1 Screen Configuration

The OPC Client screen is comprised of the following three panes. The pane configuration is shown below.

1) OPC Server Information View

Displays the connected OPC Server group and item information in a tree structure.

2) Item View

Displays the data for the item which receives the Subscription.

3) Output View

Displays the keep alive information received when the keep alive rate is enabled for the OPC group.

For more details on how to set the keep alive rate, refer to "3.4.1 Generating the Subscription (Group and Item Registration)".

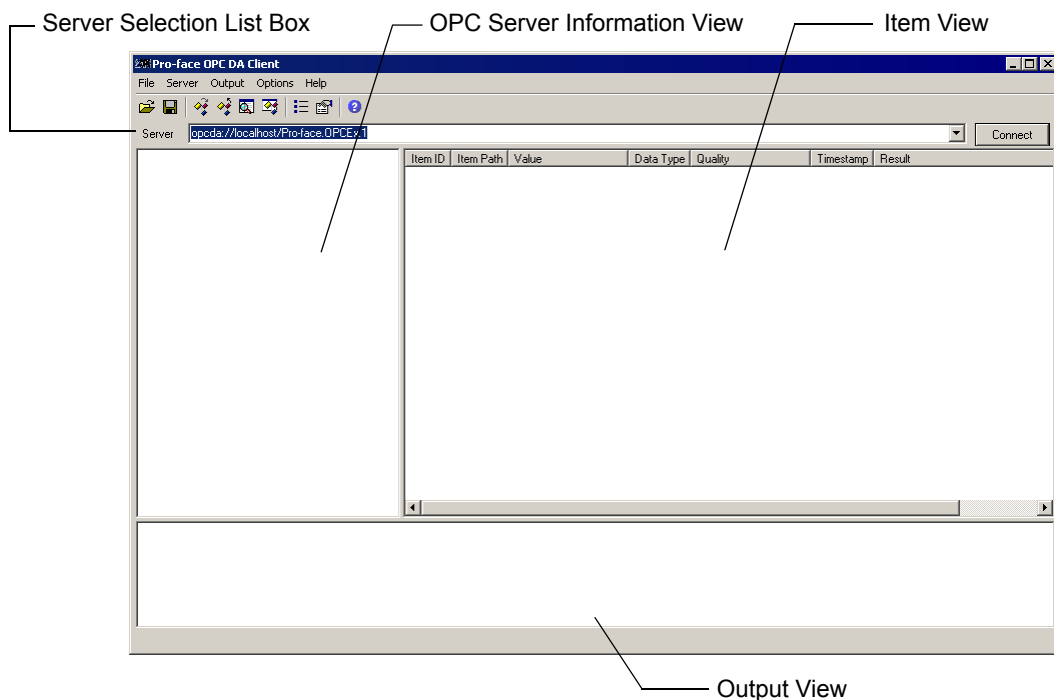

3.1.2 Menu Bar

The menu configuration of the OPC Client is shown below.

Menu		Description
File		
	Load	Loads the saved group or item information of the OPC Server.
	Save	Saves the group or item information of the currently connected OPC Server.
	Exit	Exits the OPC Client.
Server		
	Connect	Connects to the OPC Server. "3.2.1 Connecting to the OPC Server"
	Disconnect	Disconnects from the currently connected OPC Server. "3.2.2 Disconnecting from the OPC Server"
	View Server Status	Displays the status of the currently connected OPC Server. "3.2.3 Checking the OPC Server Status"
	Browse Items	Browses the OPC Server items. "3.9 Browsing OPC Server Items"
	Read Items	Reads data from the items on the connected OPC Server. "3.3.1 Synchronously Reading Item Data"
	Write Items	Writes data into the items on the connected OPC Server. "3.3.2 Synchronously Writing Item Data"
Output		
	Clear	Clears the information displayed on the Output View.
Options		
	Clear History	Clears the connection history from the server selection list box.
Help		
	Reference Manual	Displays the Reference Manual (this book).
	About	Displays the version information etc. about the OPC Client.

3.2 Connecting to and Disconnecting from the OPC Server

3.2.1 Connecting to the OPC Server

To allow the OPC Client to connect to the OPC Server, select the target OPC Server from the [Server] selection list box ("OPC Server" is selected as default).

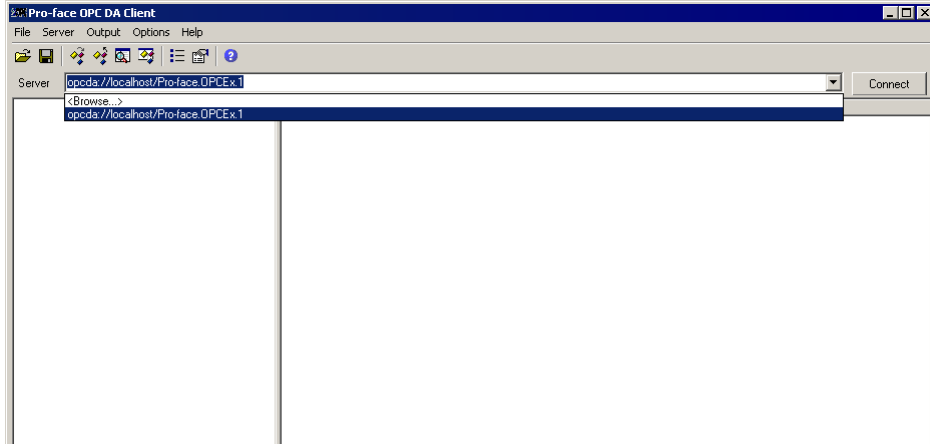

IMPORTANT

- To allow the OPC Client to remotely access the OPC Server, the security and DCOM settings are required to be adjusted in Windows. Refer to "2.6 Environment Setting When Operating OPC Server and OPC Client on Different PCs" for more details.
- While connected to the OPC Server, do not perform a reload using 'Pro-Server EX'. To change the network project, shut down all connections to the OPC Server before performing a reload.

NOTE

- For more details about the security and DCOM settings in Windows, also refer to the following documents issued by OPC-Foundation:
 - Using OPC via DCOM with Windows XP Service Pack2

If there is no OPC Server in the [Server] selection list box, select "<Browse...>" from the [Server] selection list box. You can select the OPC Server from the [Select Server] dialog box.

When selecting the OPC Server, you can select the OPC specification (version specification) as well ("Data Access 3.00" is the default specification).

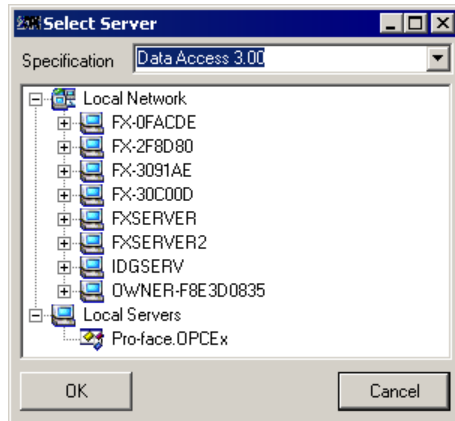

3.2.2 Disconnecting from the OPC Server

To disconnect from the OPC Server, select [Disconnect] from the [Server] menu. Or right-click on the connected OPC Server in the tree view to display the pop-up menu, and select [Disconnect].

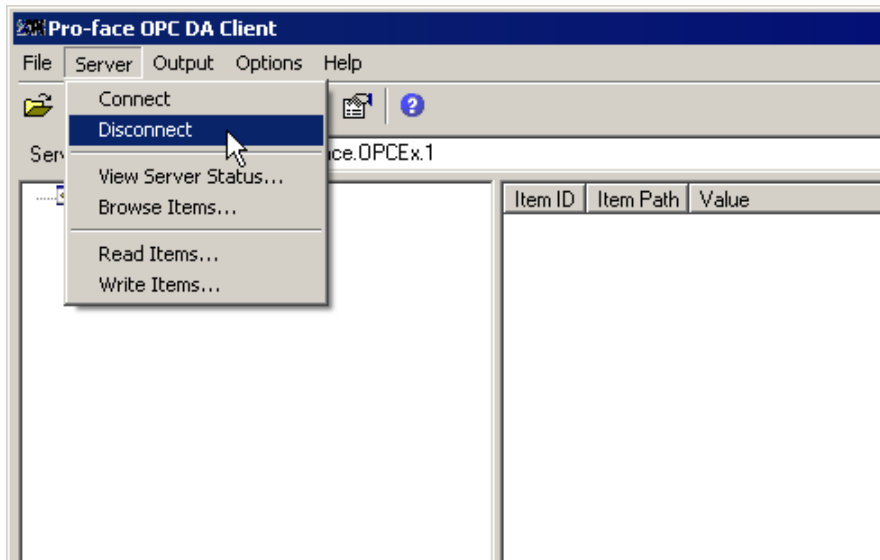

3.2.3 Checking the OPC Server Status

To display the OPC Server status, select [View Server Status] from the [Server] menu. Or right-click on the connected OPC Server in the tree view to display the pop-up menu, and select [View Server Status].

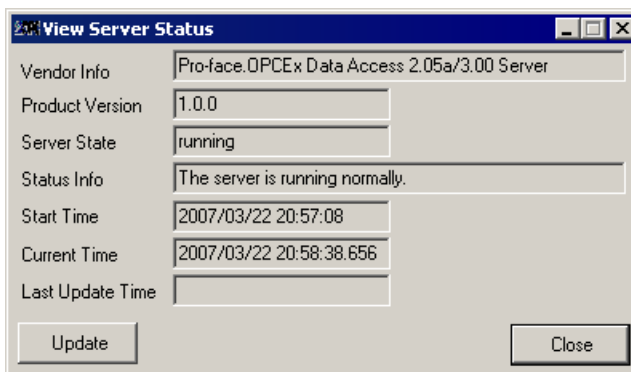
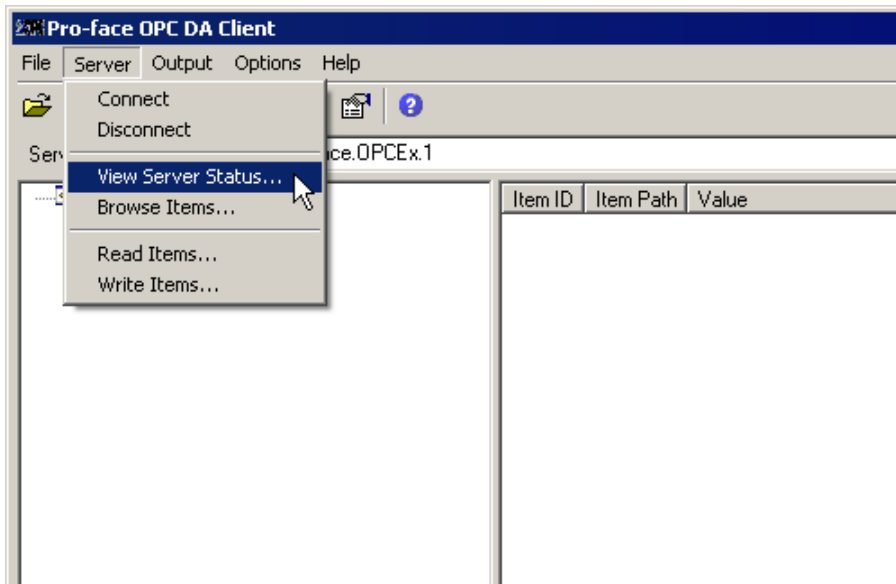

NOTE • The last update time indicates the Time Stamp when the OPC Server data changes.

3.3 Synchronously Reading/Writing Item Data

3.3.1 Synchronously Reading Item Data

To synchronously read OPC Server items, select [Read Items] from the [Server] menu. Or right-click on the connected OPC Server in the tree view to display the pop-up menu, and select [Read Items].

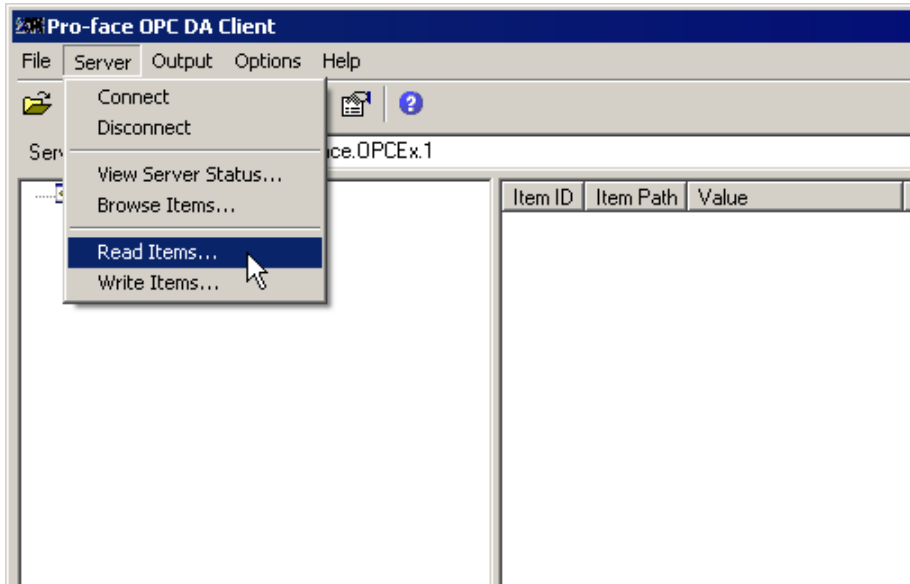

When you select [Read Items], the following [Read Items] window is displayed:

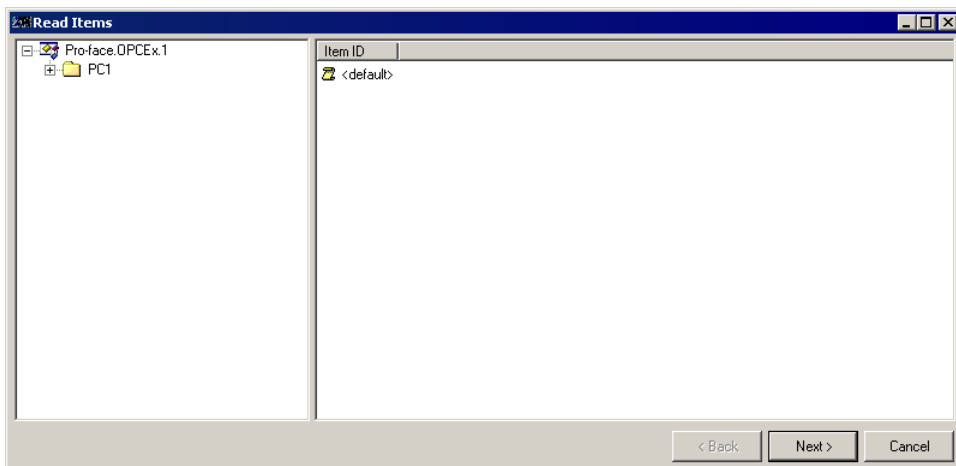

To select all items on the node, select the node corresponding to the branch in the tree view displayed on the left pane after the [Read Items] window is displayed, right-click on it and the pop-up menu appears.

Select [Select Children] from the pop-up menu.

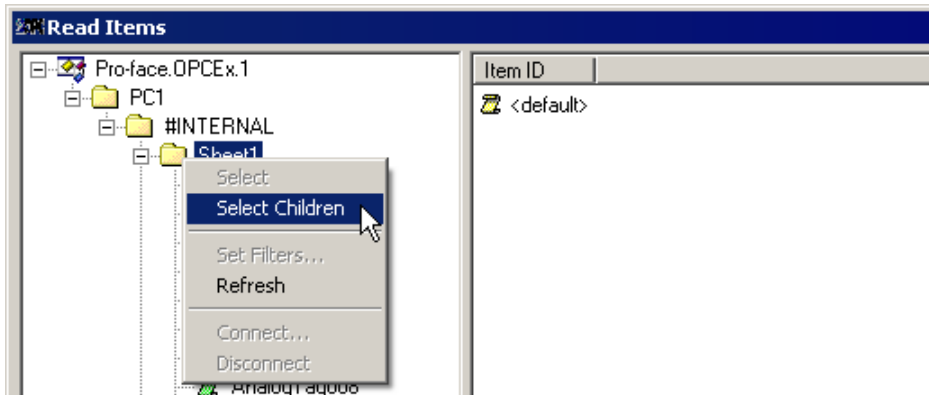

When selecting [Select Children] from the pop-up menu, all the selected items are displayed on the right pane.

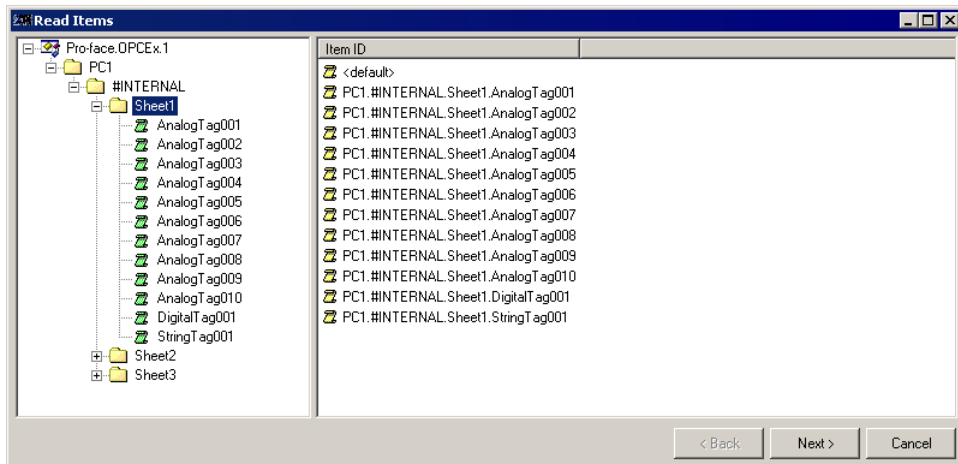

To select one item on the node, select the node corresponding to the leaf in the tree view displayed on the left pane after the [Read Items] window is displayed, right-click on it and the pop-up menu appears. Select [Select] from the pop-up menu.

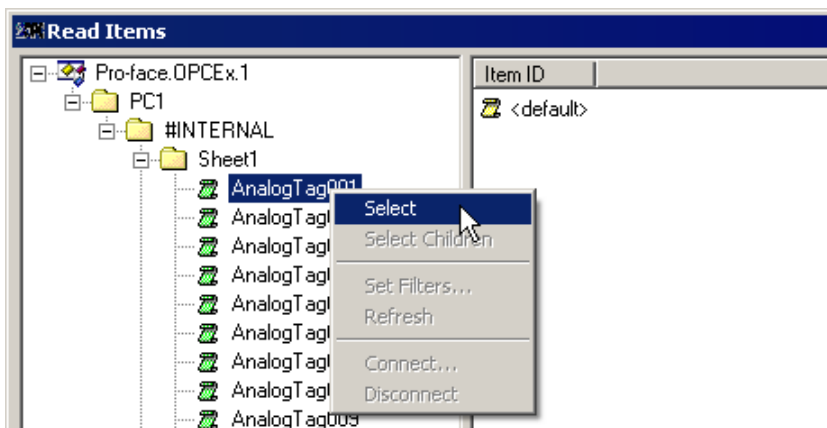

When selecting [Select] from the pop-up menu, the selected item is displayed on the right pane as shown below.

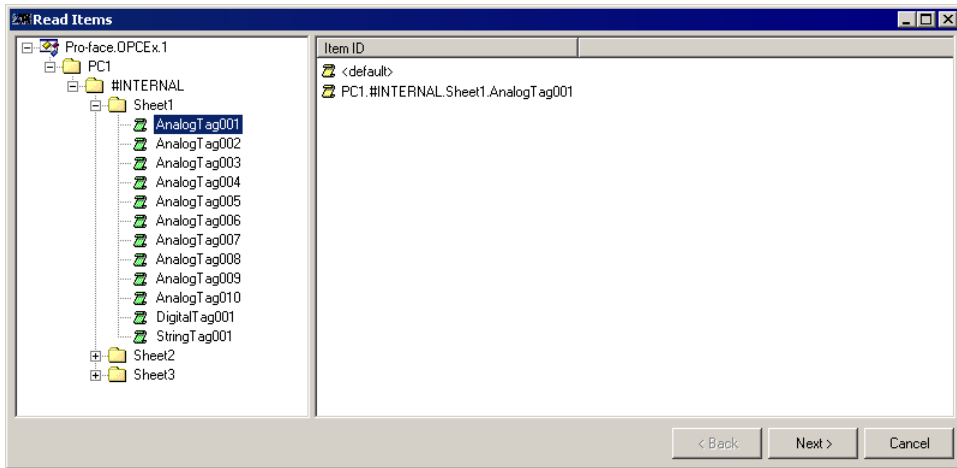

When you finish selecting the items you want to read, click [Next]. The results are displayed.

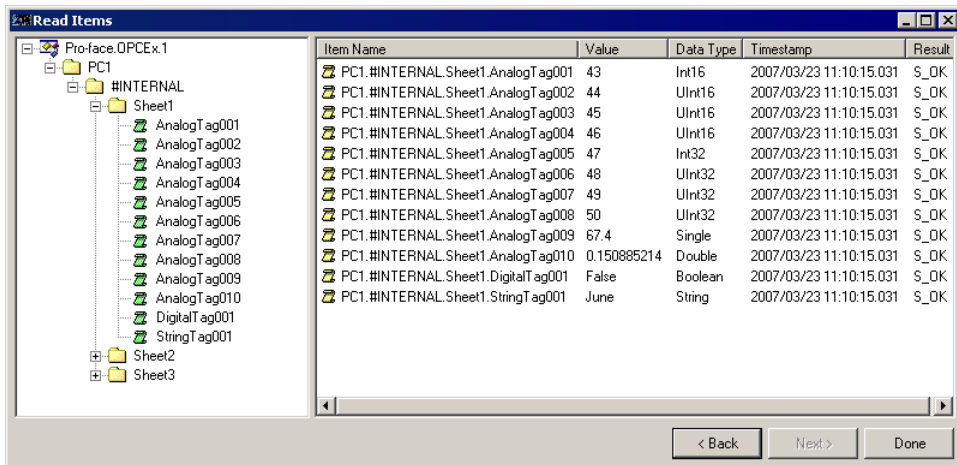

Finally, click [Done] to close the [Read Items] window. Reading is complete.

To browse the alignment item data you have read, right-click on the item displayed in the [Read Items] window to display the pop-up menu, and select [View].

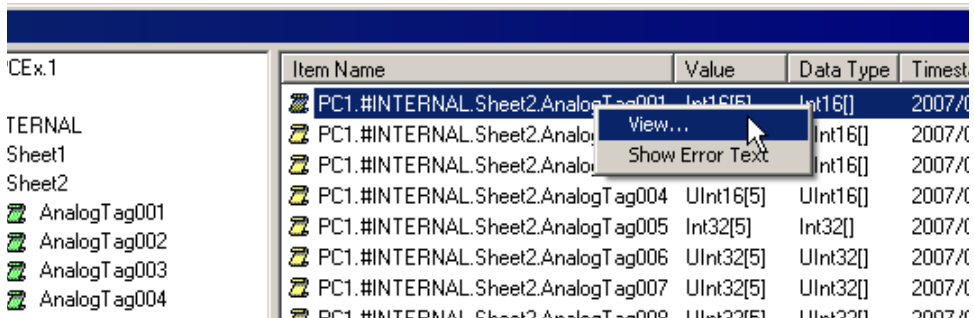

Select [View] from the menu to display the [Edit Array] window. You can confirm the value for each index.

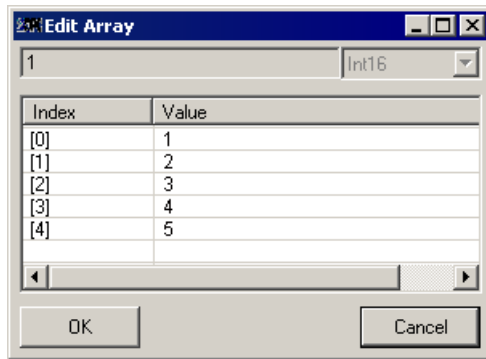

3.3.2 Synchronously Writing Item Data

To synchronously write OPC Server items, select [Write Items] from the [Server] menu. Or right-click on the connected OPC Server on the tree view to display the pop-up menu, and select [Write Items].

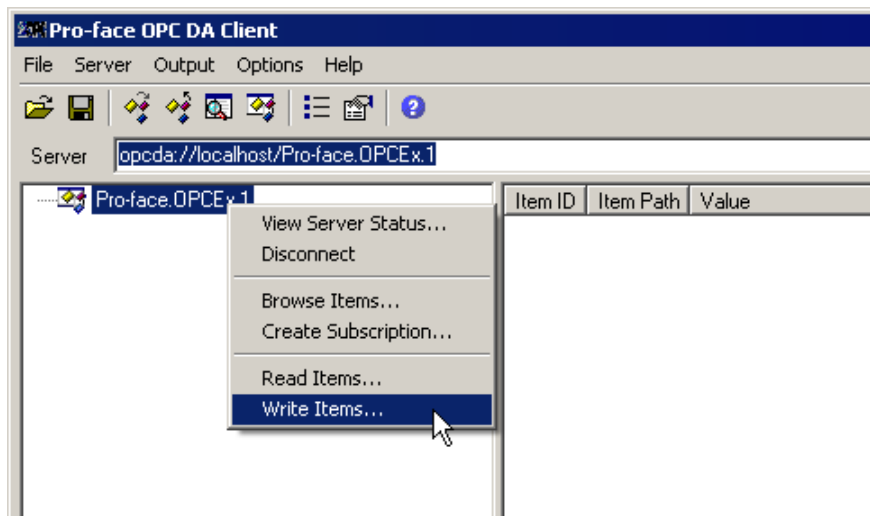

When you select [Write Items], the following [Write Items] window is displayed:

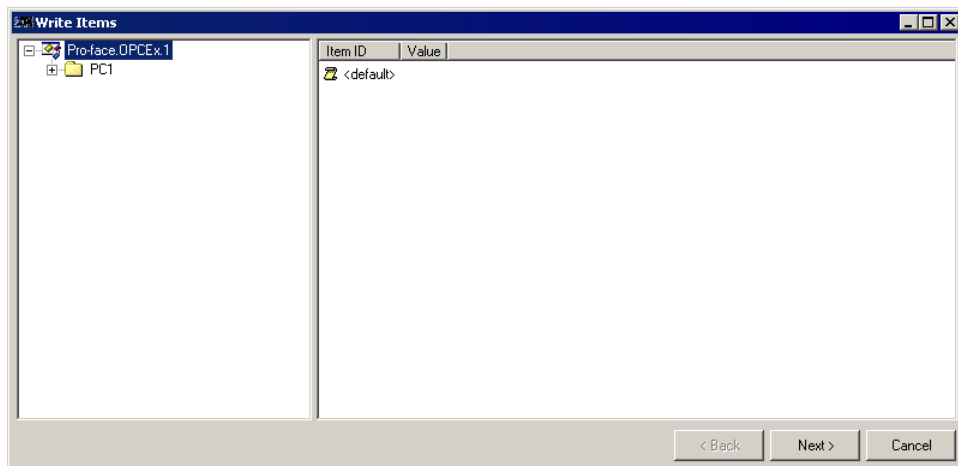

To select all items on the node, select the node corresponding to the branch in the tree view displayed on the left pane after the [Write Items] window is displayed, right-click on it and the pop-up menu appears. Select [Select Children] from the pop-up menu.

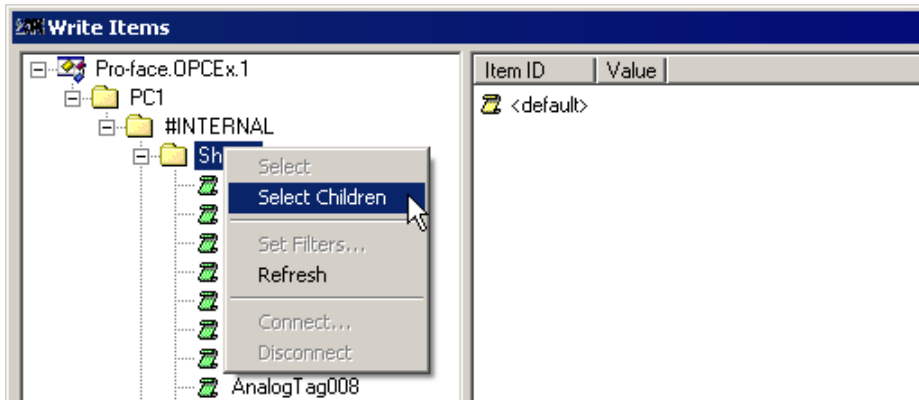

When selecting [Select Children] from the pop-up menu, all the selected items are displayed on the right pane.

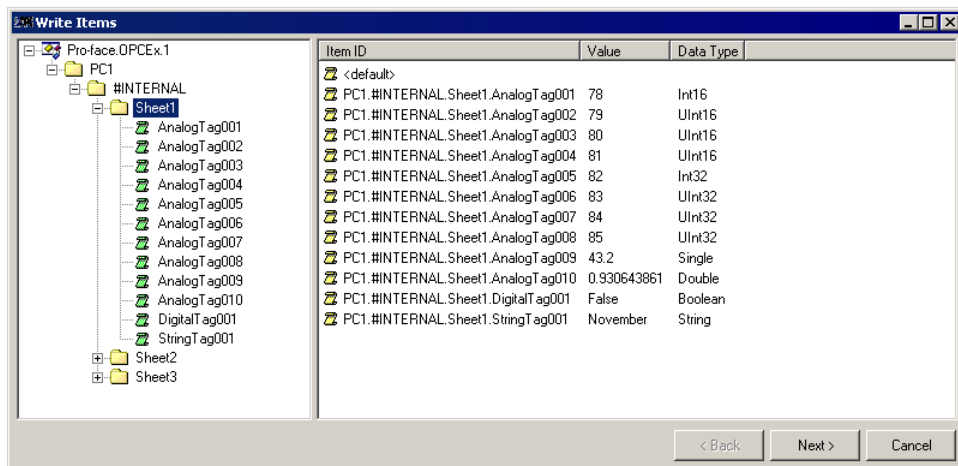

To select one item on the node, select the node corresponding to the leaf in the tree view displayed on the left pane after the [Write Items] window is displayed, right-click on it and the pop-up menu appears. Select [Select] from the pop-up menu.

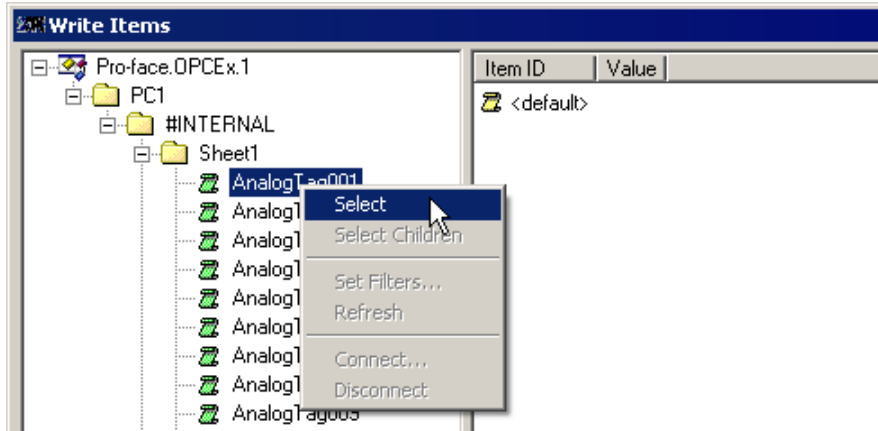

When selecting [Select] from the pop-up menu, the selected item is displayed on the right pane as shown below.

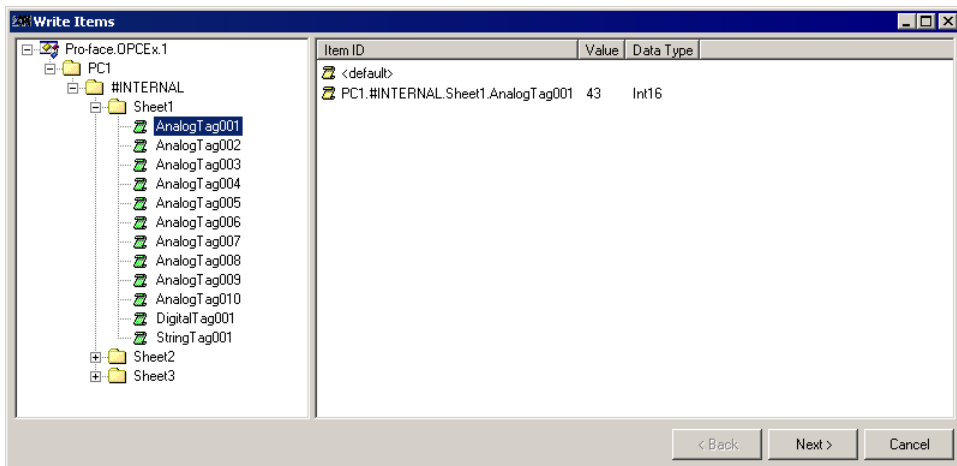

After selecting the item you want to write in, right-click on it in the right pane, and select [Edit] from the resulting menu to display the [Edit Item Values] window.

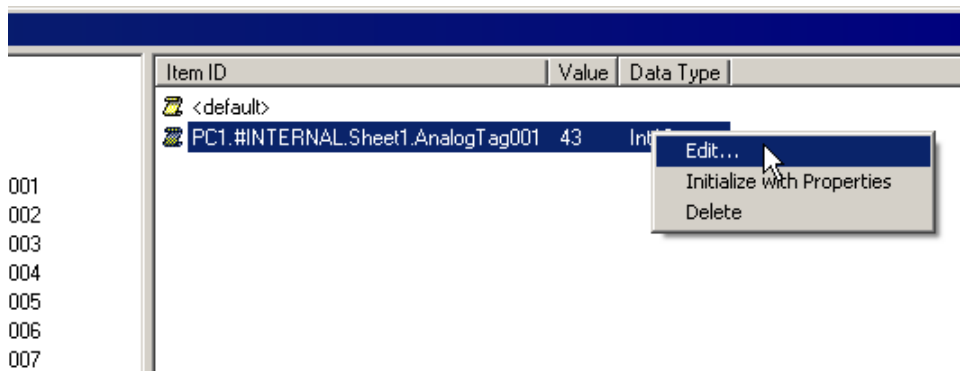

Specify the value to write and the data type in the [Edit Item Values] window.

When you finish setting, click [OK].

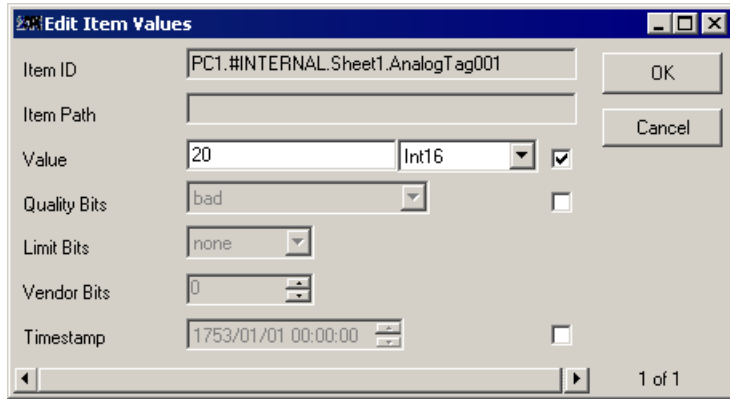

NOTE • You can also set the Quality and Time Stamp for the OPC DA Server with DA 3.0 specification.

The value you set in the [Edit Item Values] window is displayed in the [Write Items] window.

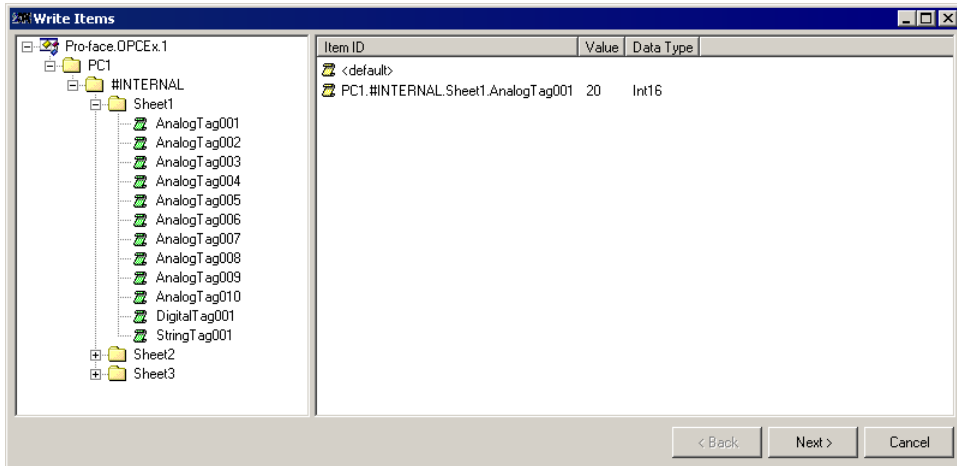

When you finish setting the items, click [Next]. The data is written onto the OPC Server.

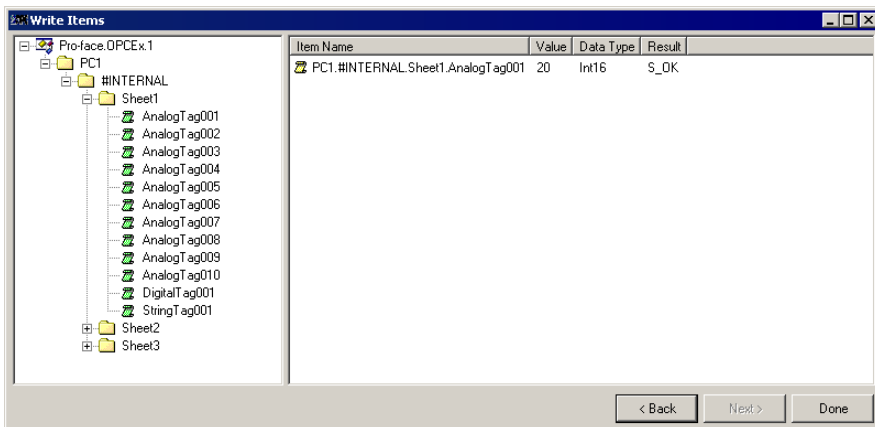

Finally, click [Done] to close the [Write Items] window. Writing is complete.

To change the alignment item data, right-click on the item displayed in the [Write Items] window to display the pop-up menu, and select [Edit].

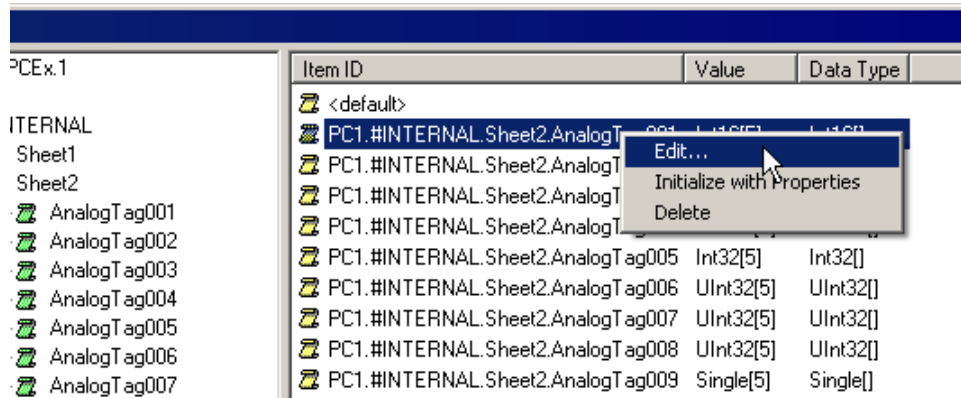

Select [Edit] from the menu to display the [Edit Item Value] window. Press "..." to display the [Edit Array] window.

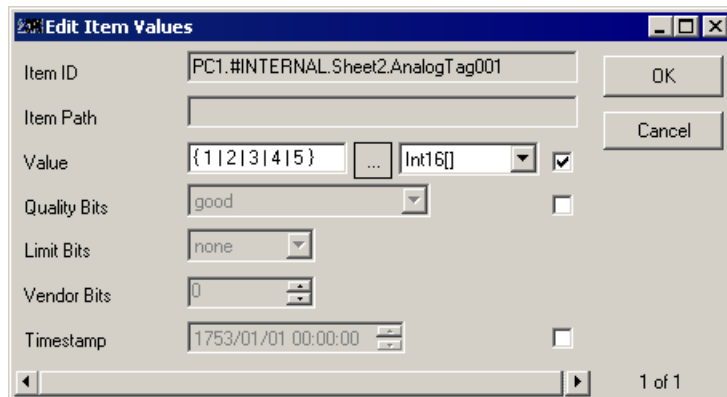

You can edit the index data in the [Edit Array] window to change the alignment item data.

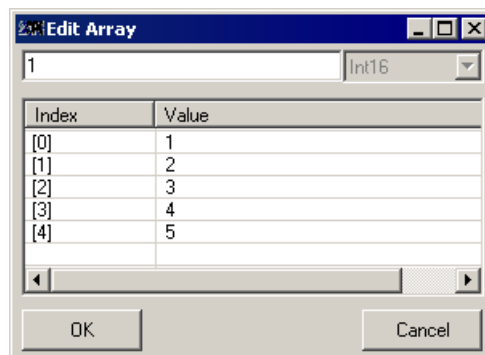

3.4 Asynchronously Reading/Writing Item Data

To asynchronously process the items for the OPC Server, create a group first. To create a group, generate the Subscription and register a group and an item.

3.4.1 Generating the Subscription (Group and Item Registration)

To register a group and an item, right-click on the connected OPC Server in the tree view on the "OPC Server Information View" pane, and select [Create Subscription] from the pop-up menu.

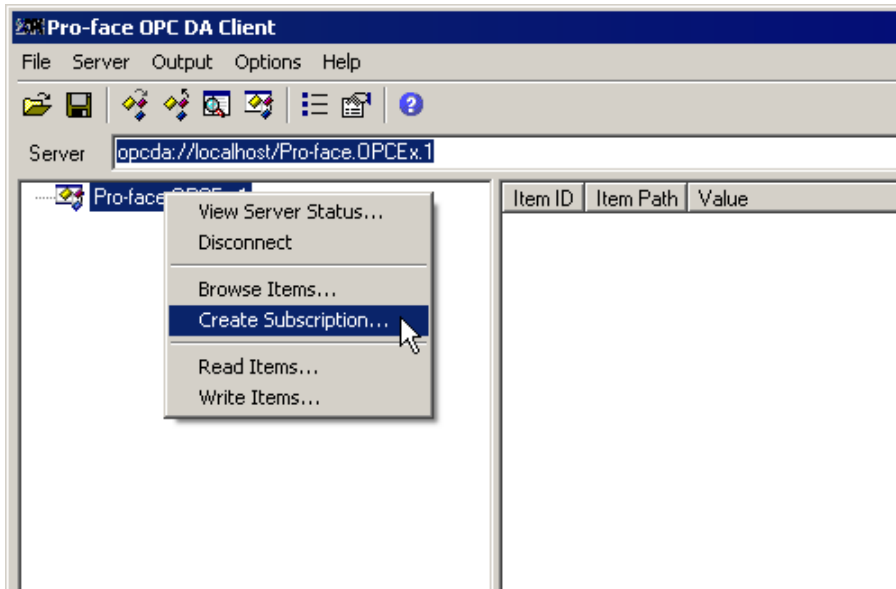

Select [Create Subscription] to display the following [Create Subscription] window:

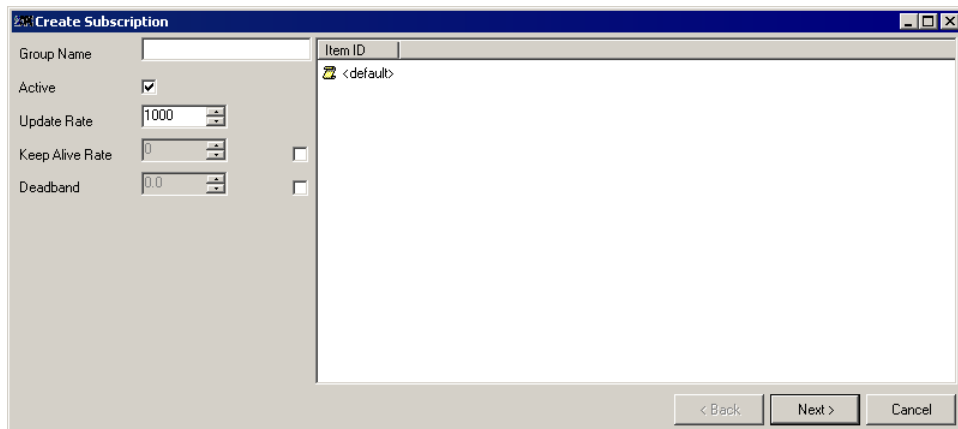

Set the following group information and click [Next]:

Setup Items	Setup Content
Group Name	Specify a group name. If you input none, an arbitrary name is set.
Active	Specify whether the Subscription distribution of the group is enabled or disabled (Receive the item data changes by Subscription from the OPC Server).
Update Rate	Specify a group update rate (ms).
Keep Alive Rate	Request the keep alive message to the OPC Server to confirm the existence (available for setting only on an OPC Server with DA 3.0 specification).
Deadband	Deadband is used to specify the rate of changes to the analog data using a %. The Deadband value is the limitation value of the rate of changes for the Subscription. The data specified in the same group updates the data cache using the update rate set for the group, and when it exceeds the rate of changes set by the Deadband, the Subscription is sent to the client. If the client does not need the subtle changes, the Deadband can be used to suppress the unnecessary Subscription.

After you click [Next], you can select the items to register. To select all items on the node, select the node corresponding to the branch in the tree view displayed on the left pane, right-click on it and the pop-up menu appears. Select [Select Children] from the pop-up menu.

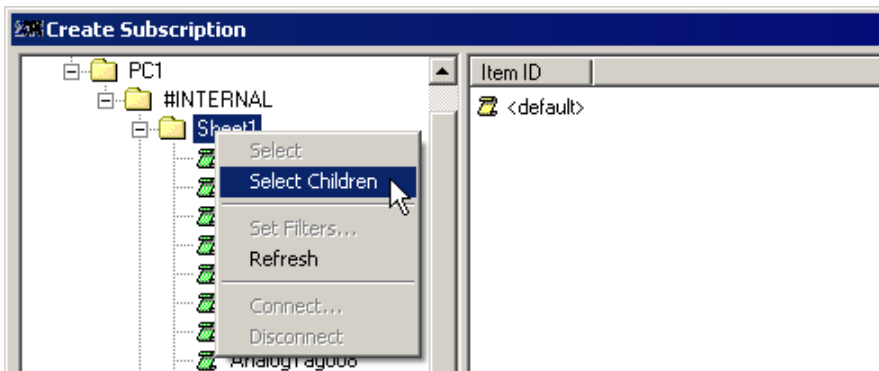

When selecting [Select Children] from the pop-up menu, all the selected items are displayed on the right pane.

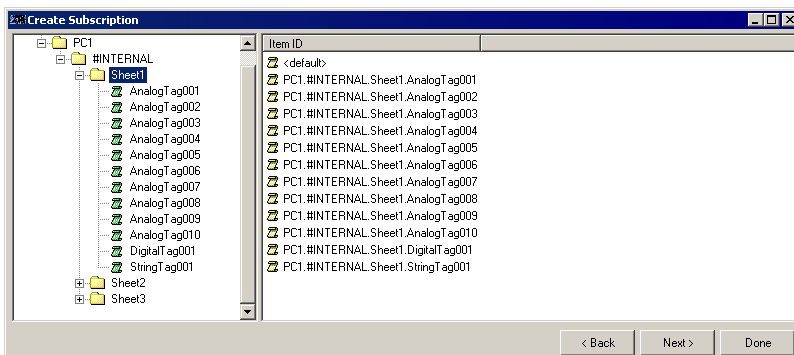

To select one item on the node, select the node corresponding to the leaf in the tree view displayed on the left pane, right-click on it and the pop-up menu appears. Select [Select] from the pop-up menu.

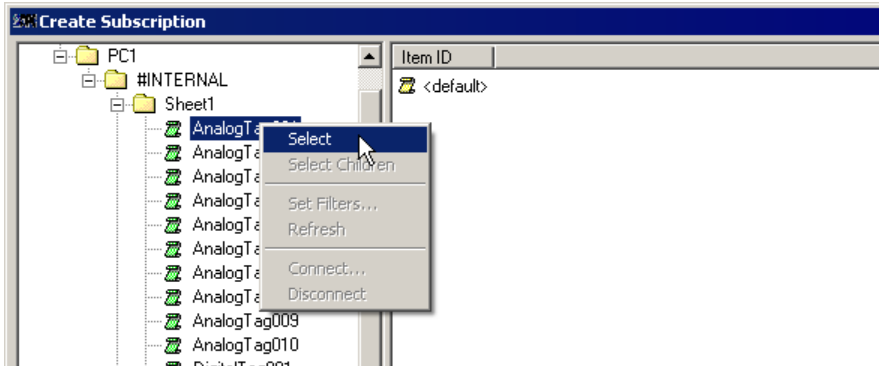

When selecting [Select] from the pop-up menu, the selected item is displayed on the right pane as shown below.

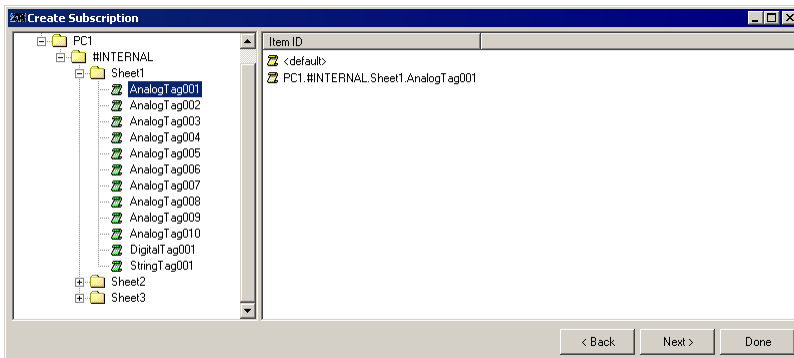

When you finish selecting the items, click [Next].

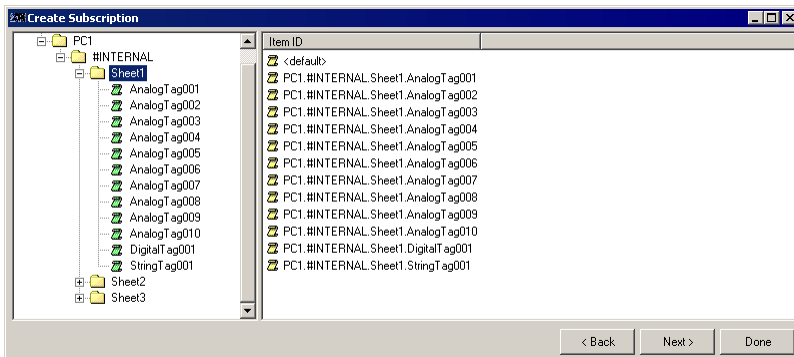

The group and items are registered on the OPC Server.

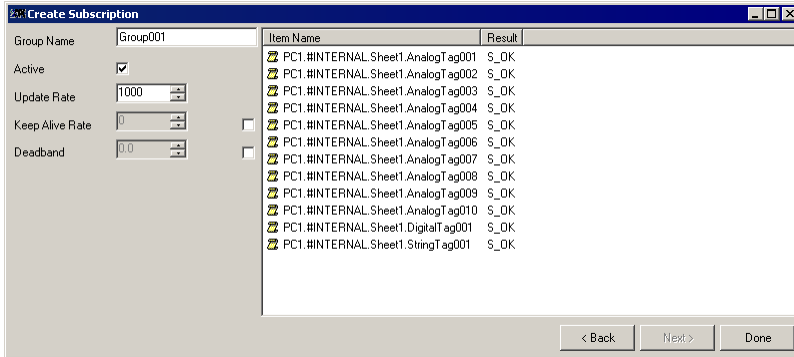

Finally, click [Done] to close the [Create Subscription] window. The group is displayed directly under the connected OPC Server in the tree view, and the Subscription starts.

Then, if the data or quality changes on the OPC Server, the data will be distributed according to the update rate.

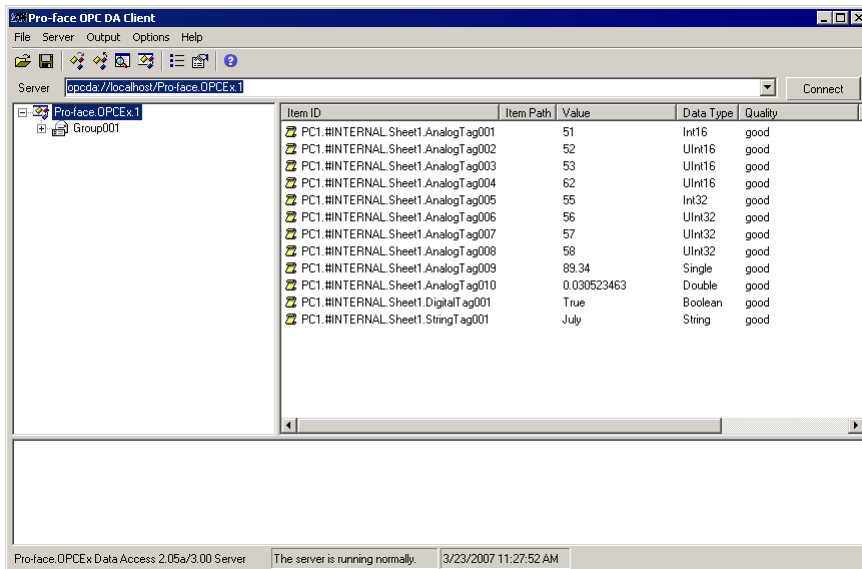

3.4.2 Editing Subscription

After the group and item registration is complete, the group is displayed directly under the connected OPC Server in the tree view. You can edit the group information for the group.

To edit the group information, right-click on the group and select [Edit Subscription] from the pop-up menu.

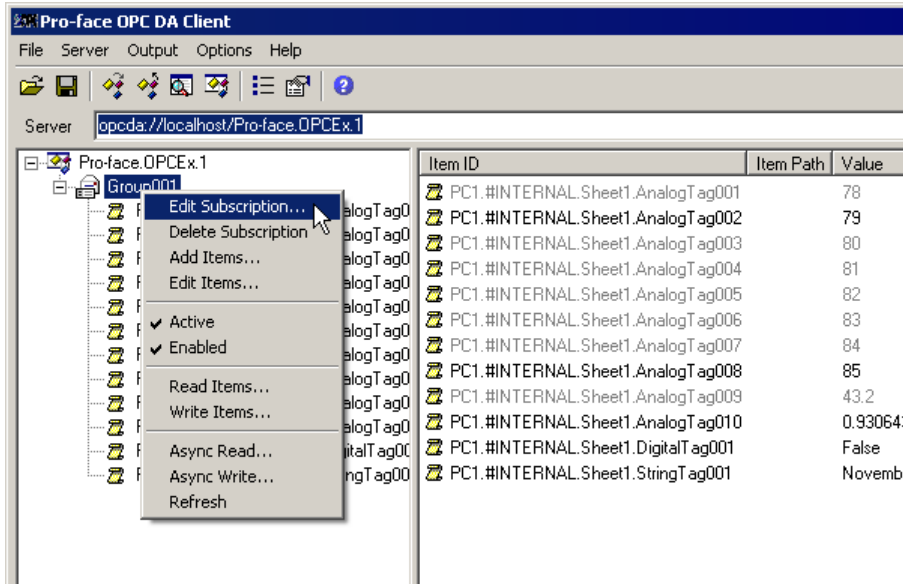

Select [Edit Subscription] to display the following [Edit Subscription] window:

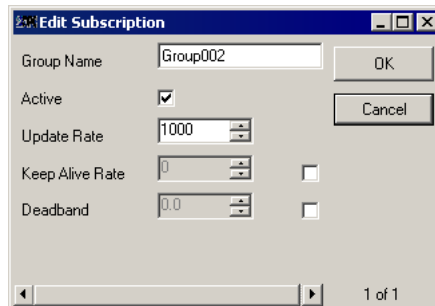

You can set the following items in the [Edit Subscription] window:

Setup Items	Setup Content
Group Name	Specify a group name. If you enter none, an arbitrary name is set.
Active	Specify whether the Subscription distribution of the group is enabled or disabled (Receive the item data changes by Subscription from the OPC Server).
Update Rate	Specify a group update rate (ms).
Keep Alive Rate	Request the keep alive message to the OPC Server to confirm the existence (available for setting only on an OPC Server with DA 3.0 specification).
Deadband	Deadband is used to specify the rate of changes to the analog data using a %. The Deadband value is the limitation value of the rate of changes for the Subscription. The data specified in the same group updates the data cache using the update rate set for the group, and when it exceeds the rate of changes set by the Deadband, the Subscription is sent to the client. If the client does not need the subtle changes, the Deadband can be used to suppress the unnecessary Subscription.

When you finish setting the group information, click [OK] to close the [Edit Subscription] window.

3.4.3 Deleting Subscription

After the group and item registration is complete, the group is displayed directly under the connected OPC Server in the tree view. You can delete the displayed group.

To delete the group, right-click on it and select [Delete Subscription] from the pop-up menu.

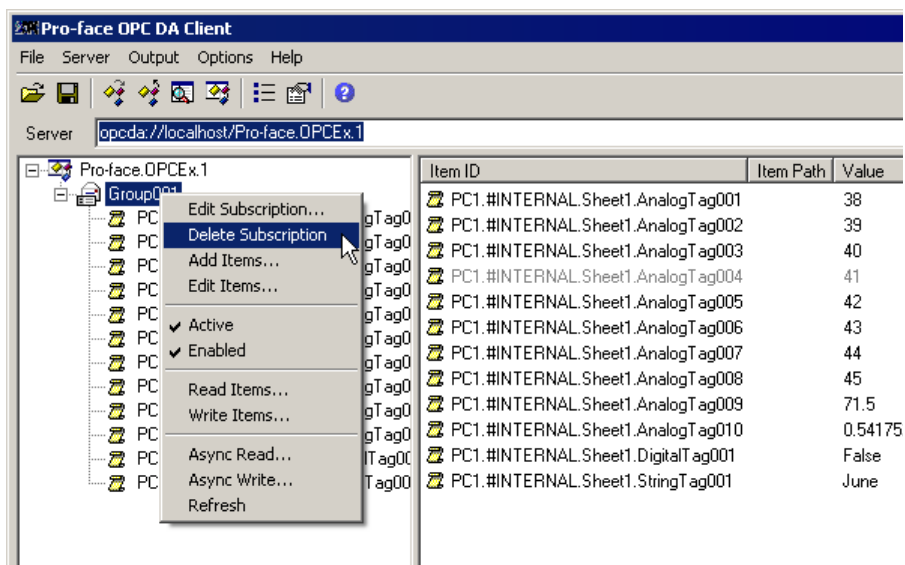

3.4.4 Adding Items

After the group and item registration is complete, the group is displayed directly under the connected OPC Server in the tree view. You can add items to the displayed group.

To add items, right-click on the group and select [Add Items] from the pop-up menu.

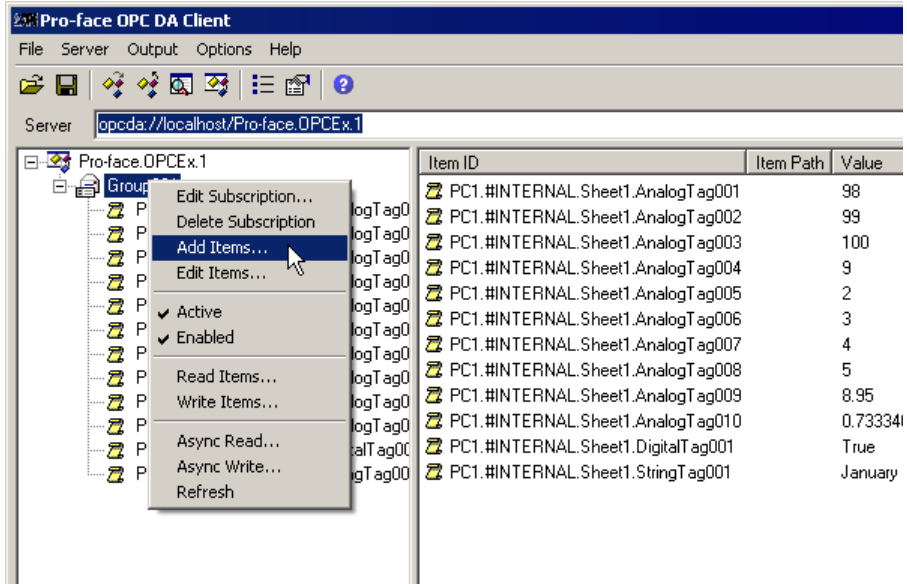

Select [Add Items] to display the following [Add Subscription Items] window:

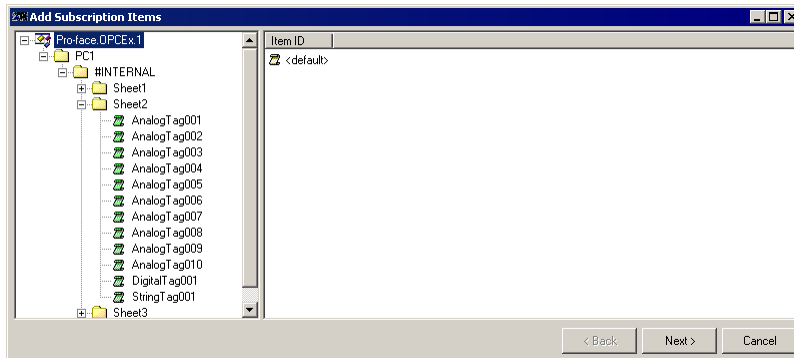

When the [Add Subscription Items] window is displayed, you can select the desired items. To select all items on the node, select the node corresponding to the branch in the tree view displayed on the left pane, right-click on it and the pop-up menu appears.

Select [Select Children] from the pop-up menu.

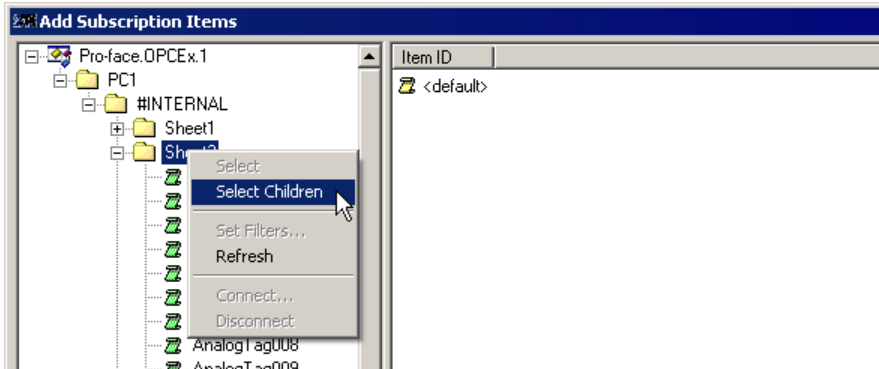

When selecting [Select Children] from the pop-up menu, all the selected items are displayed on the right pane.

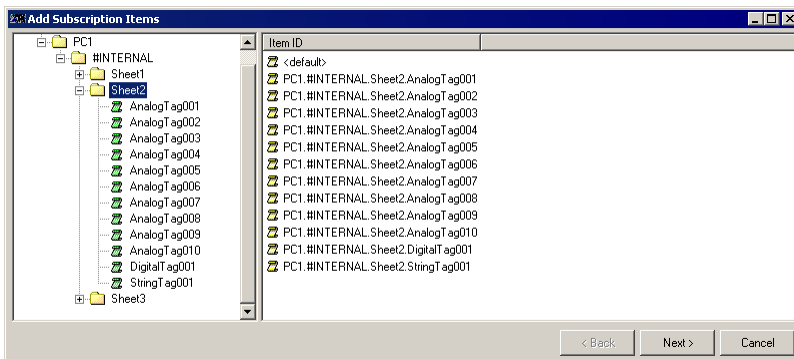

To select one item on the node, select the node corresponding to the leaf in the tree view displayed on the left pane, right-click on it and the pop-up menu appears.

Select [Select] from the pop-up menu.

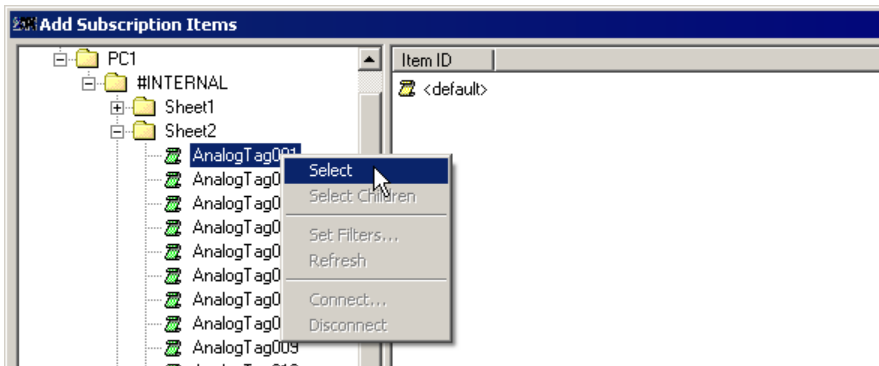

When selecting [Select] from the pop-up menu, the selected item is displayed on the right pane as shown below.

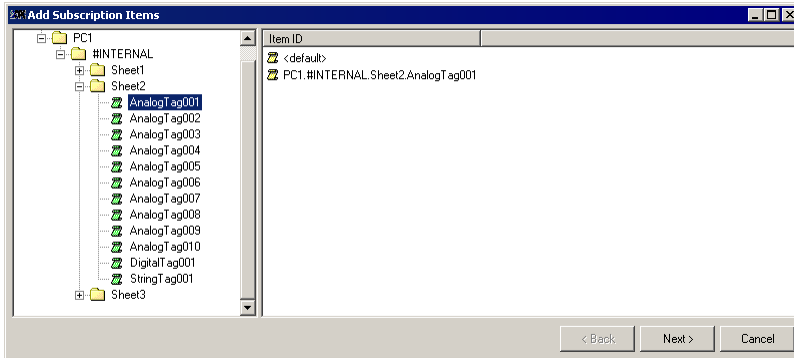

When you finish selecting the desired items and click [Next], the items are added.

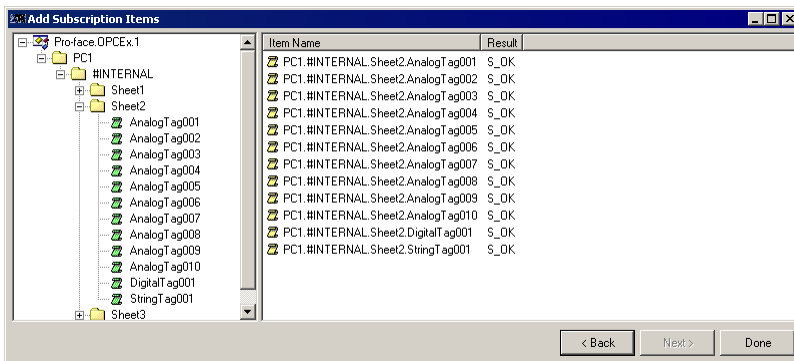

Finally, click [Done] to close the [Add Subscription Items] window. The Subscription starts.

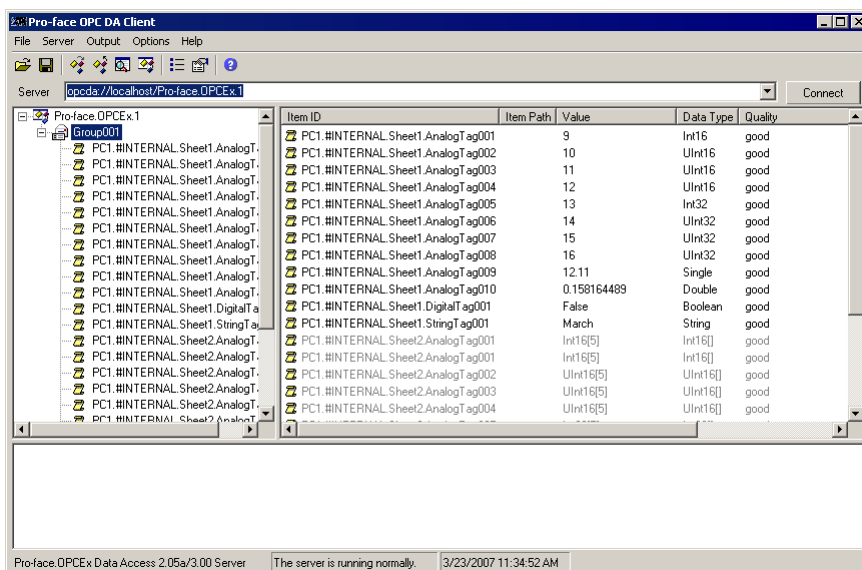

3.4.5 Editing Items

After the group and item registration is complete, the group is displayed directly under the connected OPC Server in the tree view. You can edit the items in the displayed group.

To edit the items, right-click on the group and select [Edit Items] from the pop-up menu. Then, you can edit the item information for all items in the group.

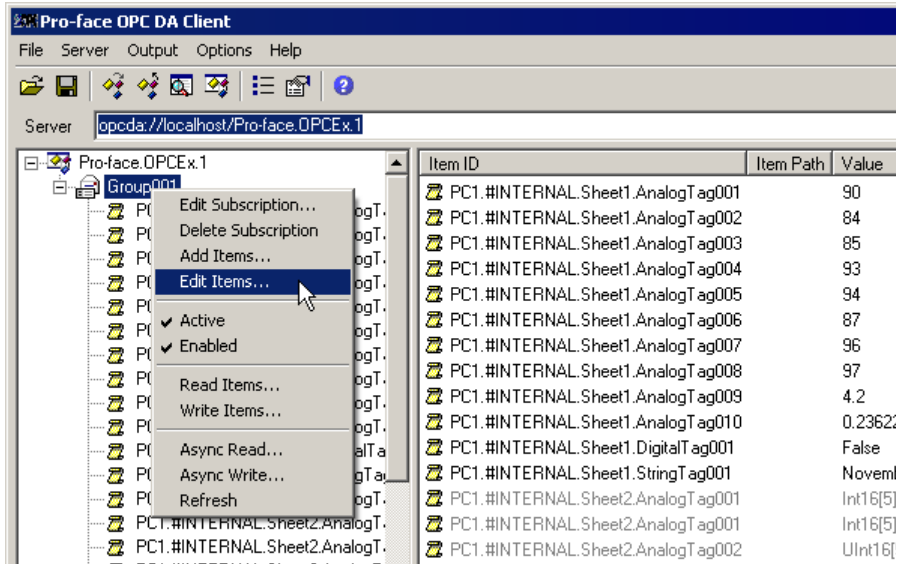

Select [Edit Items] to display the following [Edit Items] window:

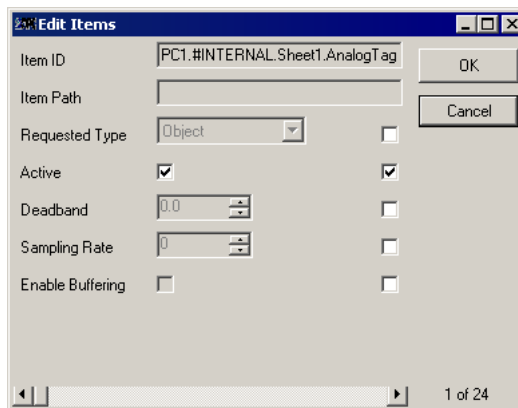

You can set the following items for each item in the [Edit Items] window. You can move the horizontal scroll bar on the [Edit Items] window to edit the next item.

- Requested Type (conversion of canonical (server) data type)
- Active
- Deadband
- Sampling Rate (ms) (available for setting only on an OPC Server with DA 3.0 specification)
- Enable Buffering (available for setting only on an OPC Server with DA 3.0 specification)

When you finish setting the item information, click [OK] to close the [Edit Items] window. To edit the items individually, refer to "3.6.1 Editing Items".

3.5 Canceling and Restarting the Subscription Data Distribution

You can cancel or restart the Subscription data distribution using the two methods shown below.

3.5.1 Using the Active/Inactive Group Setting

After the group and item registration is complete, the group is displayed directly under the connected OPC Server in the tree view. You can set Active/Inactive for the displayed group.

To set Active/Inactive for the group, right-click on the group and select [Active] from the pop-up menu.

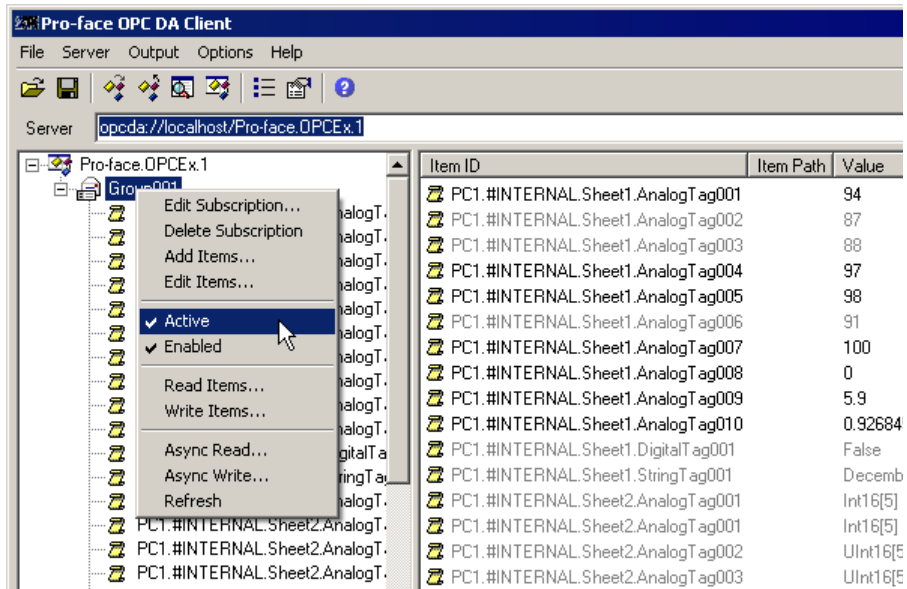

On the pop-up menu, selecting [Active] with a checkmark () to its left changes the setting to Inactive.

Selecting [Active] without a checkmark to its left changes the setting to Active, which restarts the Subscription data distribution.

The Active/Inactive Group Setting is performed by the SetState method of IOPCGroupStateMgt interface.

3.5.2 Using Asynchronous I/O Object

After the group and item registration is complete, the group is displayed directly under the connected OPC Server in the tree view. You can set the asynchronous processing to Enable/Disable for the asynchronous object included in the displayed group.

To set the asynchronous processing to Enable/Disable, right-click on the group, and select [Enabled] from the pop-up menu.

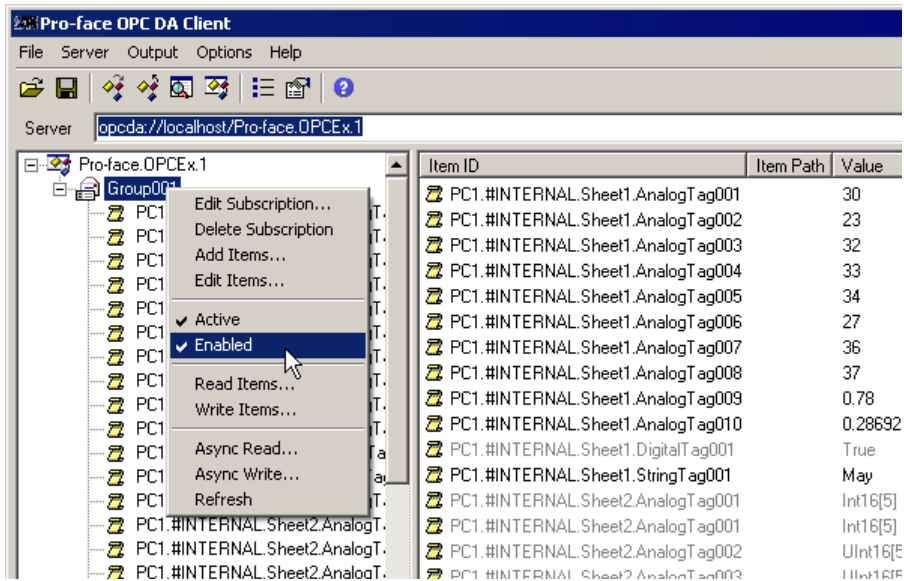

On the pop-up menu, selecting [Enabled] with a checkmark () to its left changes the setting to Disabled.

Selecting [Enabled] without a checkmark to its left changes the setting to Enabled, which restarts the Subscription data distribution.

The Enable/Disable setting of the asynchronous object is performed by the SetEnabl method of IOPCAsyncIO2/ IOPCAsyncIO3 interface.

3.6 Editing and Deleting Items

3.6.1 Editing Items

After the group and item registration is complete, the group and items are displayed directly under the connected OPC Server in the tree view. You can edit the items included in the displayed group individually.

To edit the items individually, right-click on the desired item and select [Edit] from the pop-up menu.

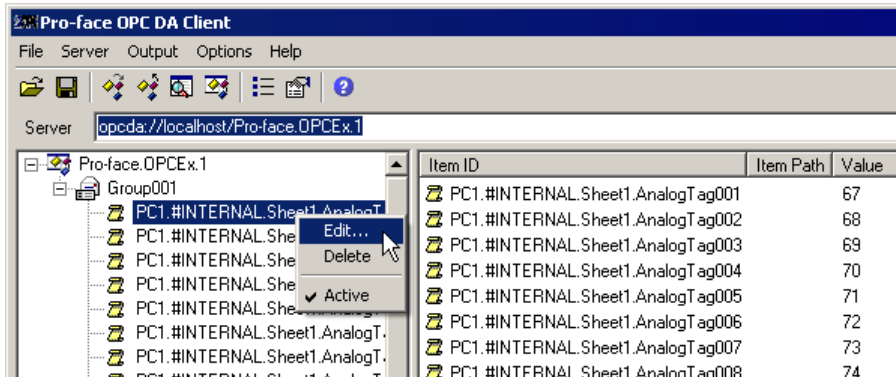

Select [Edit Items] to display the following [Edit Items] window:

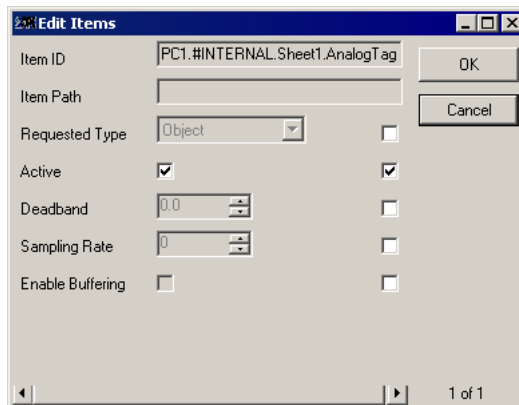

You can set the following items for each item in the [Edit Items] window:

- Requested Type (conversion of canonical (server) data type)
- Active
- Deadband
- Sampling Rate (ms) (available for setting only on an OPC DA Server with DA 3.0 specification)
- Enable Buffering (available for setting only on an OPC DA Server with DA 3.0 specification)

When you finish setting the item information, click [OK] to close the [Edit Items] window. To edit the items collectively, refer to "3.4.5 Editing Items".

NOTE • When you want to return the [Requested Type] setting to [Object], clear the check box and select [Object] as the [Requested Type] again.

3.6.2 Deleting Items

After the group and item registration is complete, the group and items are displayed directly under the connected OPC Server in the tree view. You can delete items included in the displayed group.

To delete an item, right-click on it and select [Delete] from the pop-up menu.

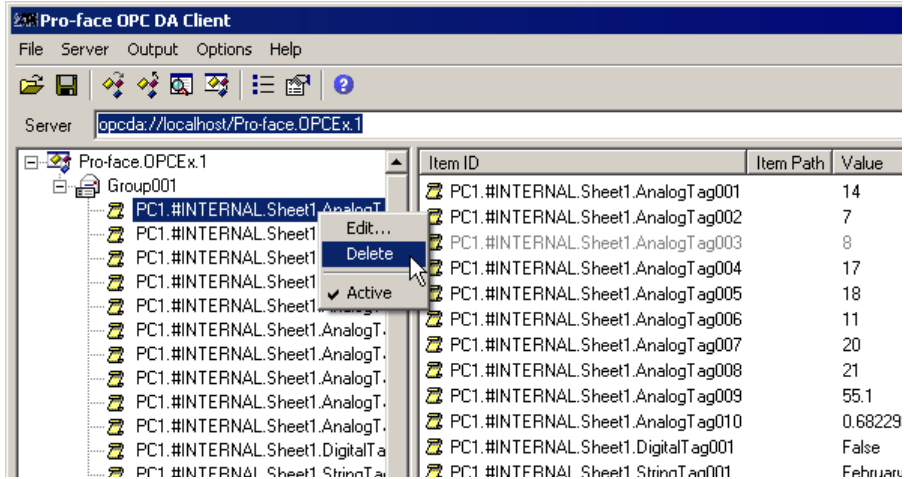

3.6.3 Activating Items

In "3.5 Canceling and Restarting the Subscription Data Distribution", the data distribution for all items in the group is canceled. You can, however, set Active or Inactive for an individual item.

After the group and item registration is complete, the group and items are displayed directly under the connected OPC Server in the tree view. You can set Active or Inactive for the items included in the displayed group.

To set Active/Inactive, right-click on the desired item and select [Active] from the pop-up menu.

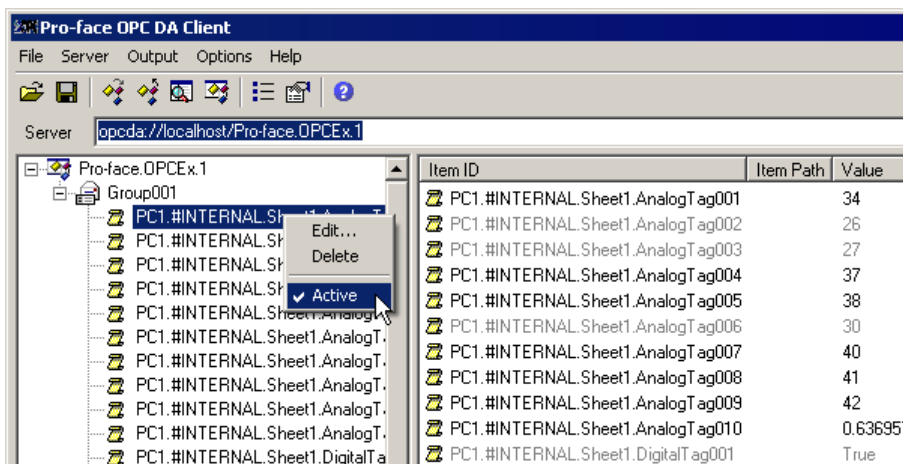

On the pop-up menu, selecting [Active] with a checkmark () to its left changes the setting to Inactive.

Selecting [Active] without a checkmark to its left changes the setting to Active, which restarts the Subscription data distribution.

3.7 Asynchronously Reading/Writing Item Data in the Group

3.7.1 Asynchronously Reading Item Data in the Group

After the group and item registration is complete, the group is displayed directly under the connected OPC Server in the tree view. You can asynchronously read the items in the displayed group.

To asynchronously read the items, right-click on the group and select [Async Read] from the pop-up menu.

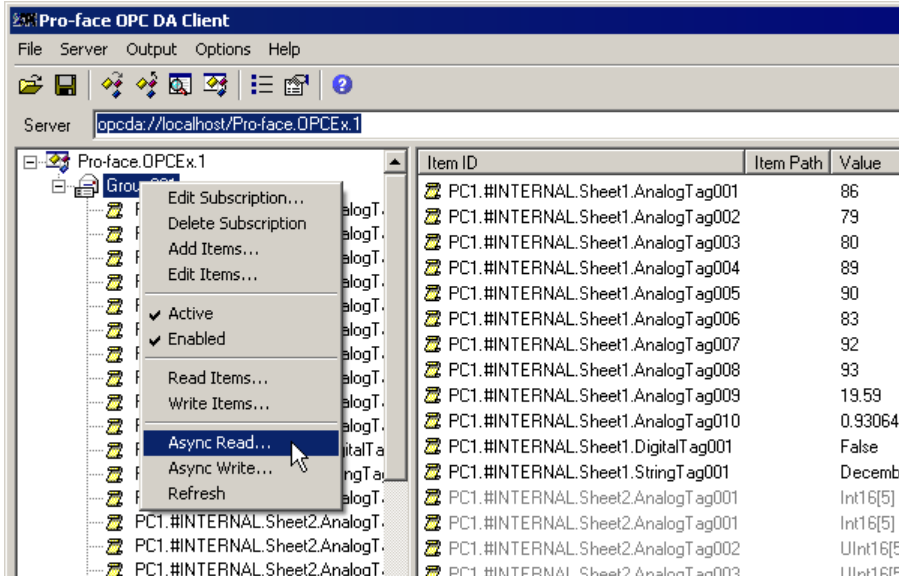

Select [Async Read] to display the following [Read Items] window:

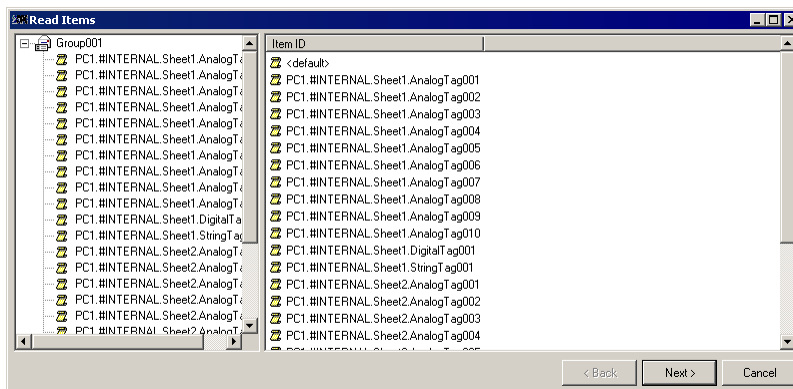

Click [Next] to display the [Asynchronous Request] window, which shows each item value, data type, time stamp, and result.

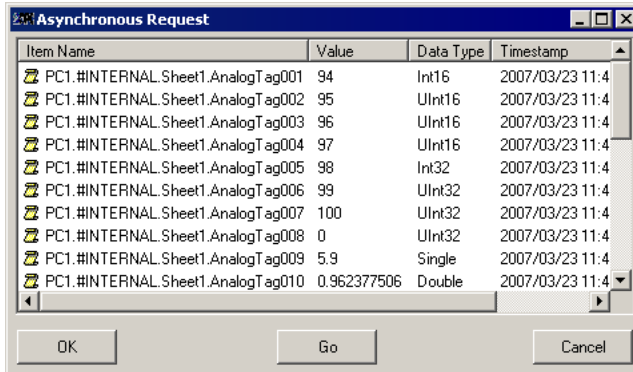

Click [Go] in the [Asynchronous Request] window to perform [Asynchronous Read Items] again. Or, click [OK] or [Cancel] to close the [Asynchronous Request] window and return to the [Read Items] window.

Finally, click [Done] to close the [Read Items] window. Asynchronously reading is complete.

To browse the alignment item data you have read, right-click on the desired item displayed in the [Asynchronous Request] window, and select [View] from the pop-up menu.

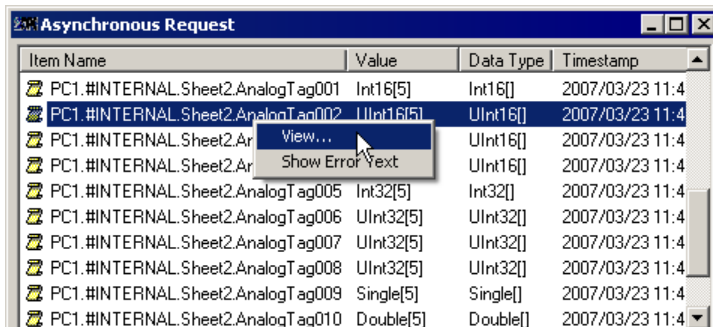

Select [View] from the menu to display the [Edit Array] window. You can then check the value for each index.

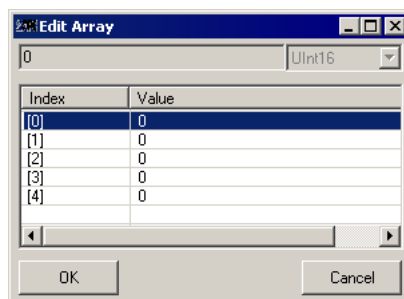

3.7.2 Asynchronously Writing Item Data in the Group

After the group and item registration is complete, the group is displayed directly under the connected OPC Server in the tree view. You can asynchronously write the items in the displayed group.

To asynchronously write the items, right-click on the group and select [Async Write] from the pop-up menu.

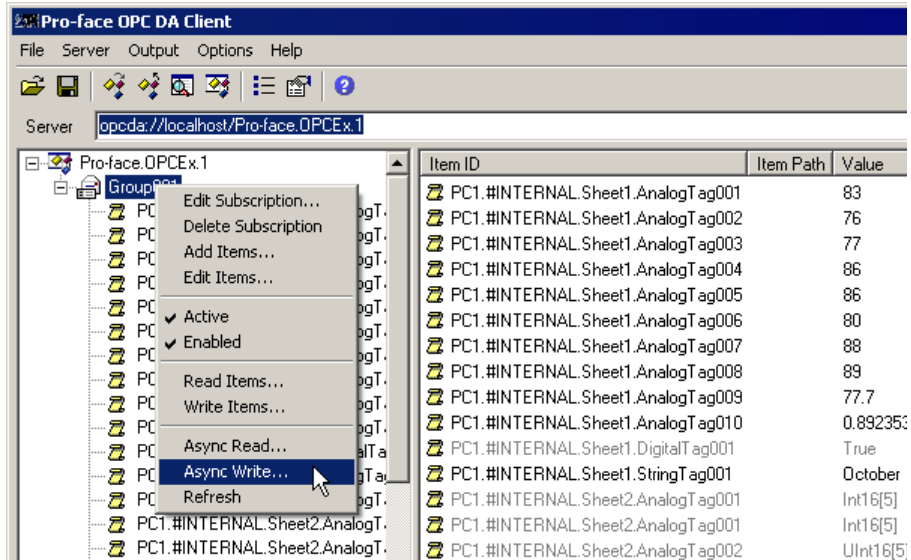

Select [Async Write] to display the following [Write Items] window. Right-click on the desired item in the right pane to display the [Edit Item Values] window.

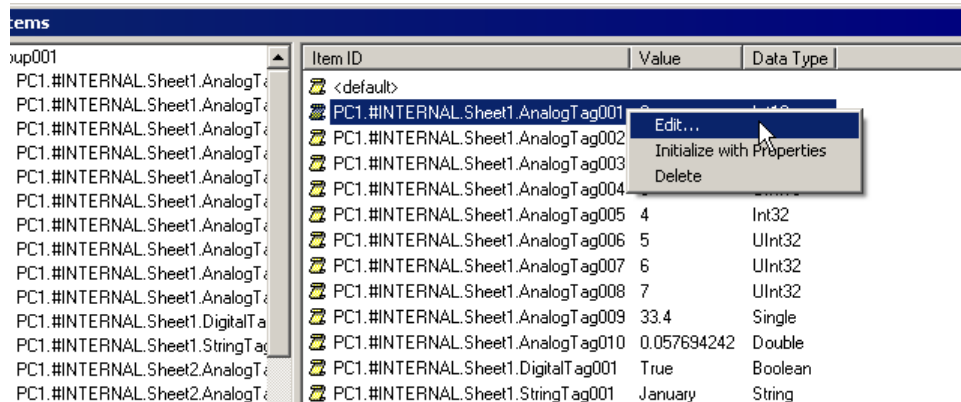

Specify the value to write and the data type in the [Edit Item Values] window.

When you finish setting, click [OK].

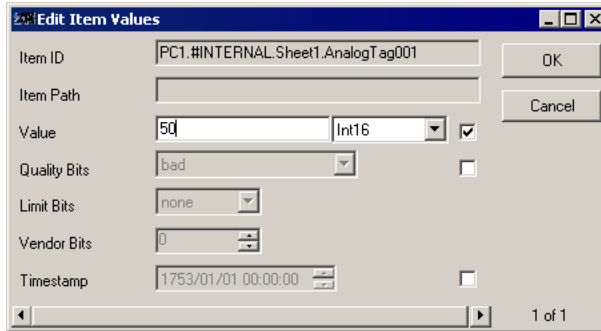

NOTE

- You can also set the Quality and Time Stamp for the OPC DA Server with DA 3.0 specification.

Click [Next] in the [Write Items] window to start writing. The [Asynchronous Request] window is displayed.

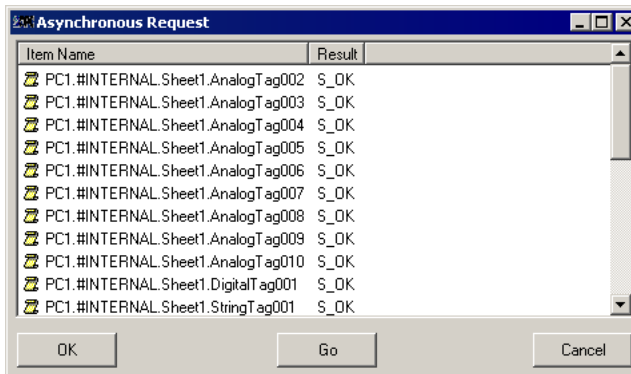

Click [Go] in the [Asynchronous Request] window to perform [Asynchronous Write Items] again. Or, click [OK] or [Cancel] to close the [Asynchronous Request] window and return to the [Write Items] window. Finally, click [Done] to close the [Write Items] window. Asynchronously writing is complete.

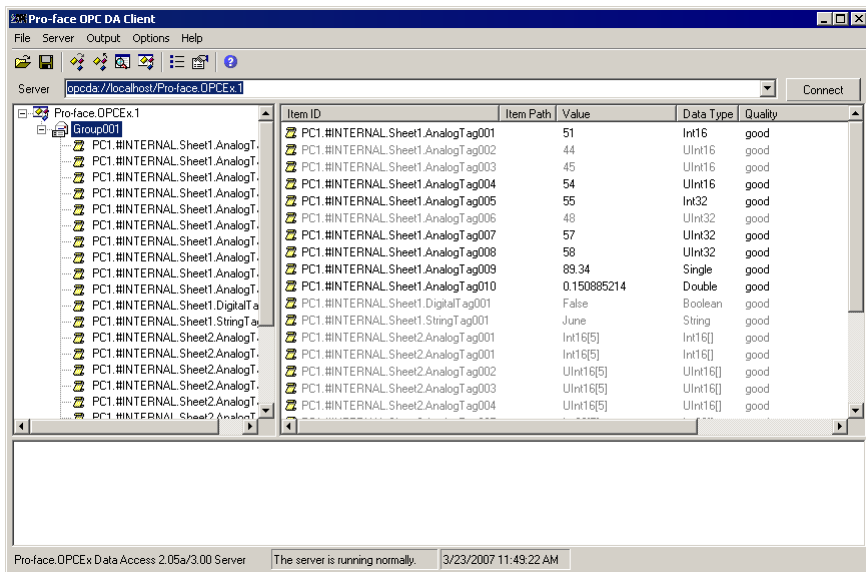

To change the alignment item data, right-click on the desired item displayed in the [Asynchronous Request] window and select [Edit] from the pop-up menu.

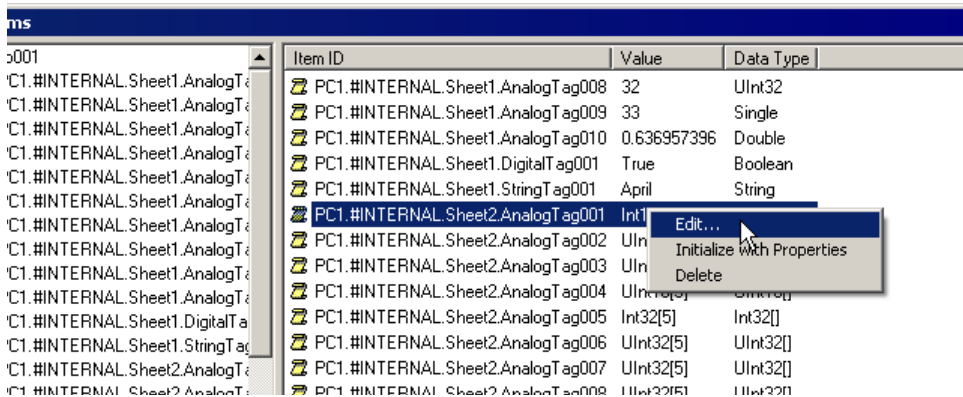

Select [Edit] from the menu to display the [Edit Item Values] window. Press "..." to display the [Edit Array] window.

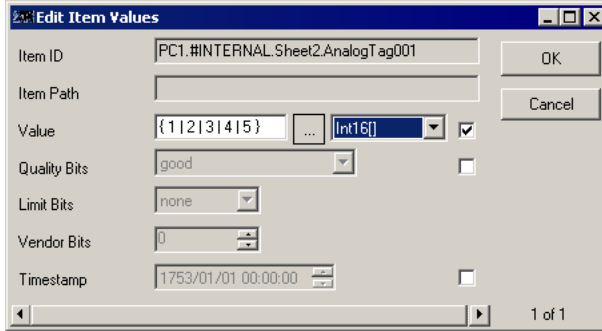

You can edit the index data in the [Edit Array] window to change the alignment item data.

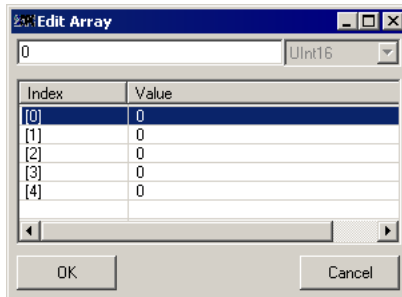

3.7.3 Refreshing Items

Refreshing is used to check that writing onto the OPC Server is performed, and can be seen on the Item View. After the group and item registration is complete, the group is displayed directly under the connected OPC Server in the tree view. You can refresh the items in the displayed group.

To refresh the items, right-click on the group and select [Refresh] from the pop-up menu.

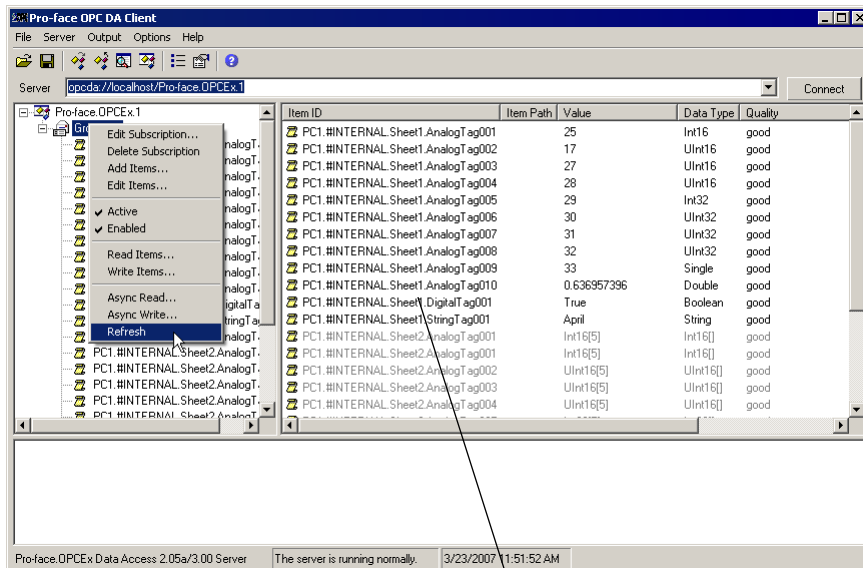

Item View

3.8 Synchronous Processing Group Items

To synchronously process the items for the OPC Server, you need to perform "Group and Item Registration" described in "3.4.1 Generating the Subscription (Group and Item Registration)".

3.8.1 Synchronously Reading Data from Group Items

After the group and item registration is complete, the group is displayed directly under the connected OPC Server in the tree view. You can synchronously read the items in the displayed group. To synchronously read the items, right-click on the group and select [Read Items] from the pop-up menu.

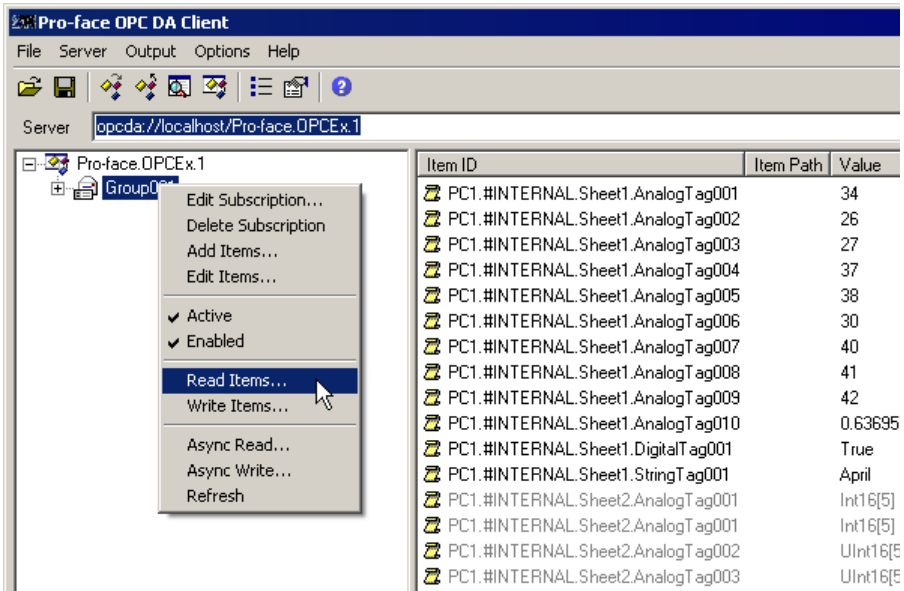

Select [Read Items] to display the following [Read Items] window:

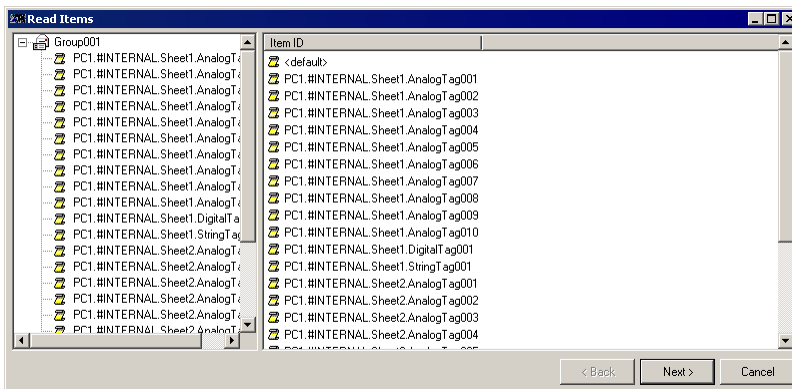

Click [Next] to display each item value, data type, time stamp, and result.

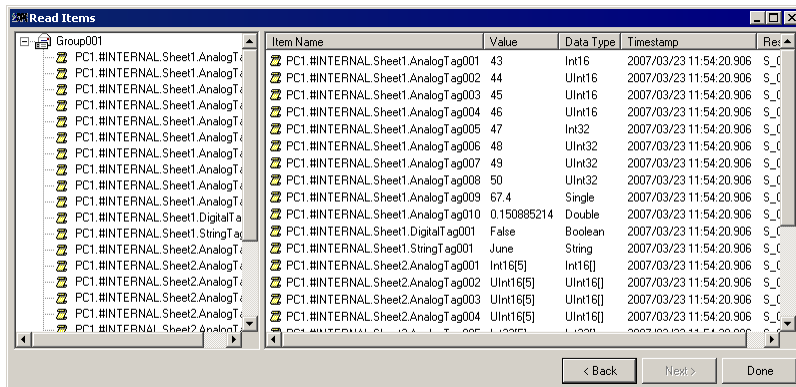

Finally, click [Done] to close the [Read Items] window. Synchronously reading is complete.

To browse the alignment item data you have read, right-click on the desired item displayed in the [Read Items] window to display the pop-up menu, and select [View].

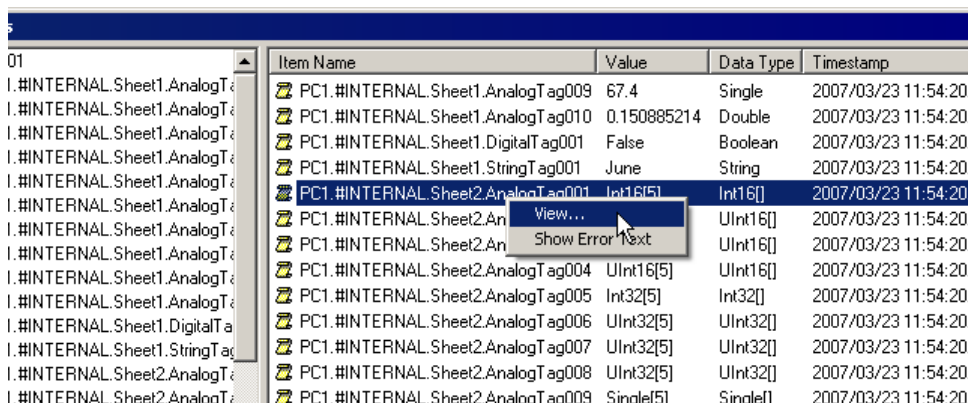

Select [View] from the menu to display the [Edit Array] window. You can then check the value for each index.

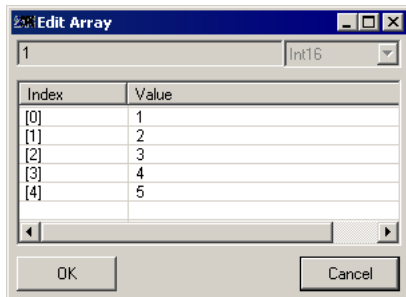

3.8.2 Synchronously Writing Data into Group Items

After the group and item registration is complete, the group is displayed directly under the connected OPC Server in the tree view. You can synchronously write the items in the displayed group.

To synchronously write the items, right-click on the group and select [Write Items] from the pop-up menu.

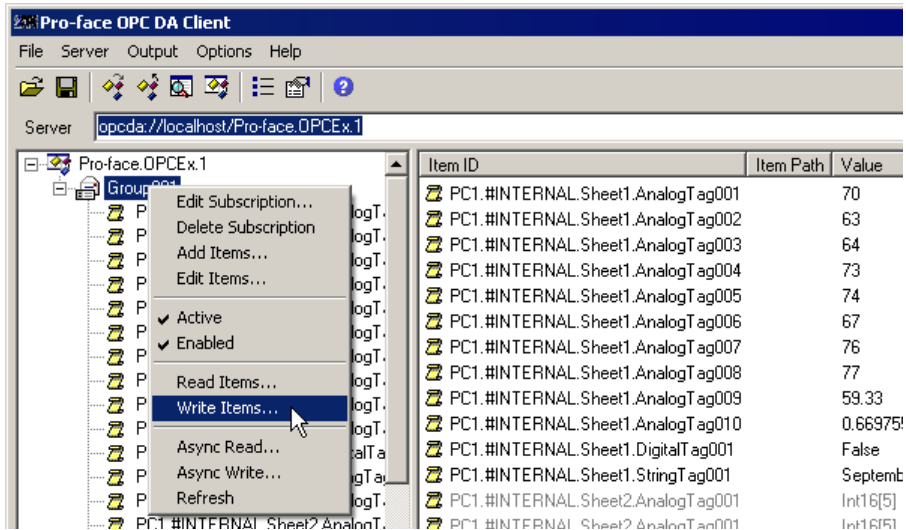

Select [Write Items] to display the following [Write Items] window. Right-click on the desired item in the right pane to display the [Edit Item Values] window.

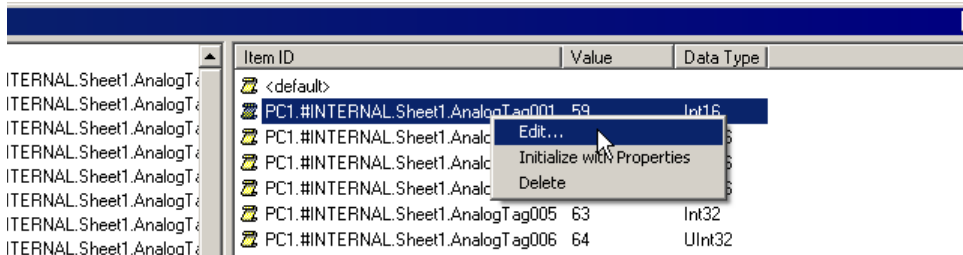

Specify the value to write and the data type in the [Edit Item Values] window.

When you finish setting, click [OK].

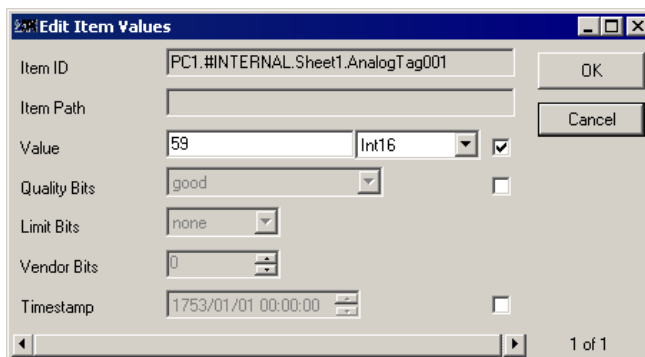

NOTE • You can also set the Quality and Time Stamp for the OPC DA Server with DA 3.0 specification.

Click [OK] in the [Edit Item Values] window. Then, click [Next] in the [Write Items] window to perform [Synchronous Write Items].

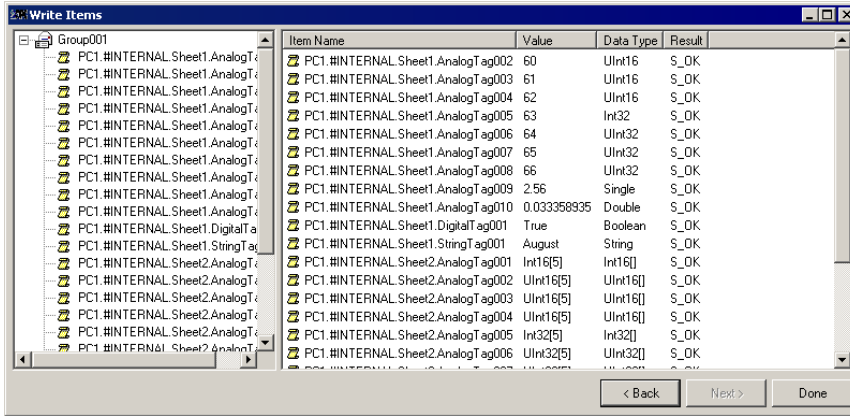

Finally, click [Done] to close the [Write Items] window. Synchronously writing is complete.

To change the alignment item data, right-click on the item displayed in the [Write Items] window to display the pop-up menu and select [Edit].

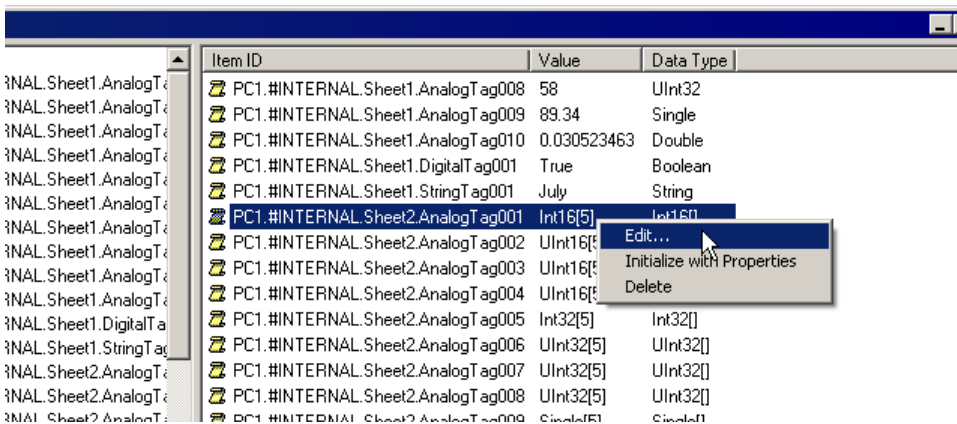

Select [Edit] from the menu to display the [Edit Item Values] window. Press "..." to display the [Edit Array] window.

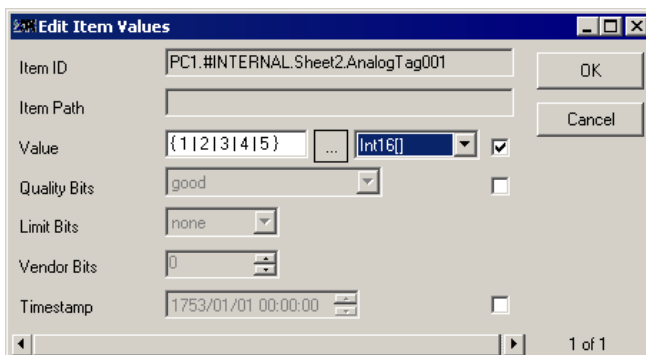

You can edit the index data in the [Edit Array] window to change the alignment item data.

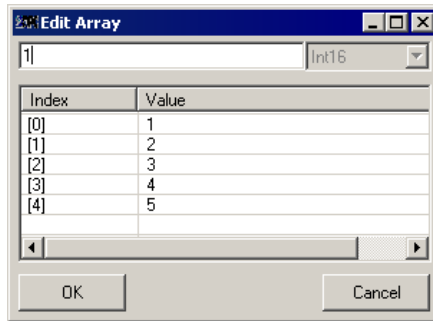

3.9 Browsing OPC Server Items

To browse the OPC Server items, select [Browse Items] from the [Server] menu. Or right-click on the connected OPC Server in the tree view to display the pop-up menu and select [Browse Items].

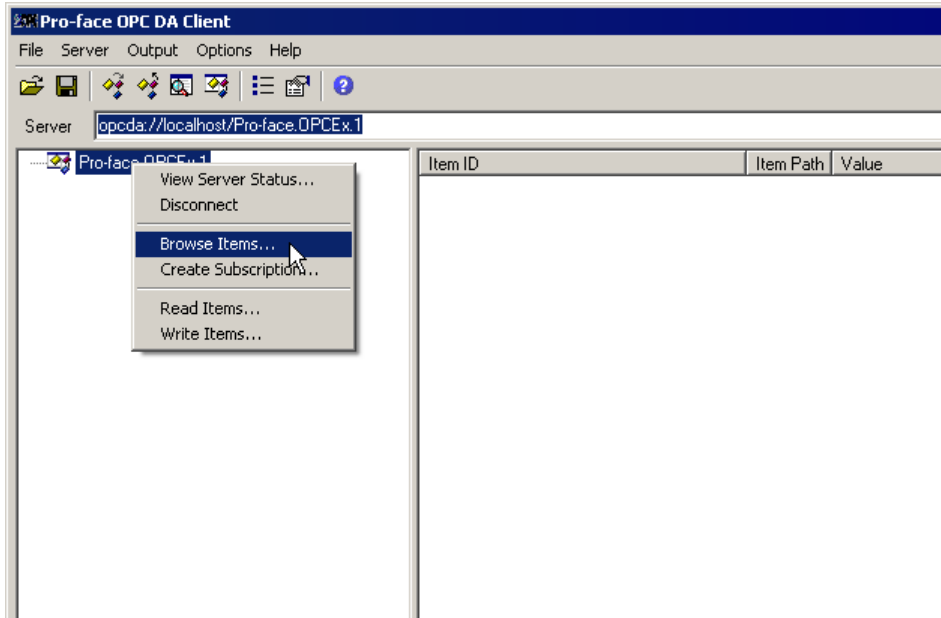

Select [Browse Items] to display the following [Browse Items] window:

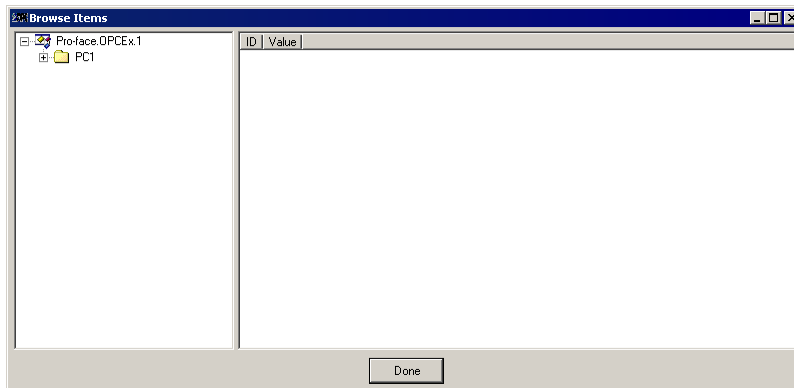

When you select the node in the tree view shown in the left pane after the [Browse Items] window is displayed, you can browse the desired item and its properties.

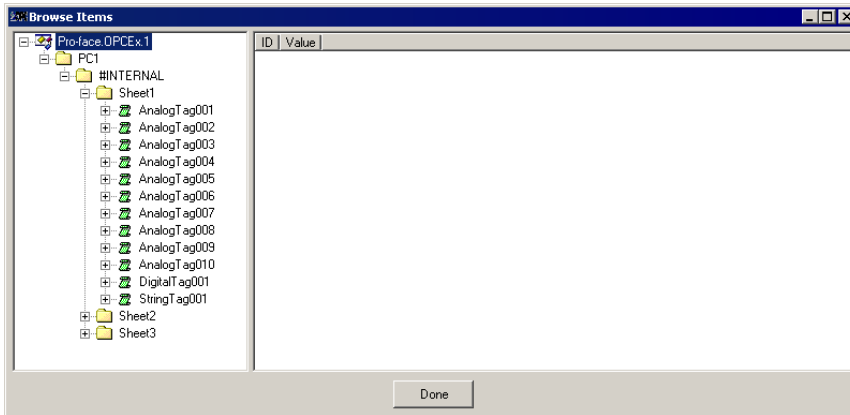

In addition, when you reach the leaf item (item on the end) in the tree view, you can display the item properties for that item.

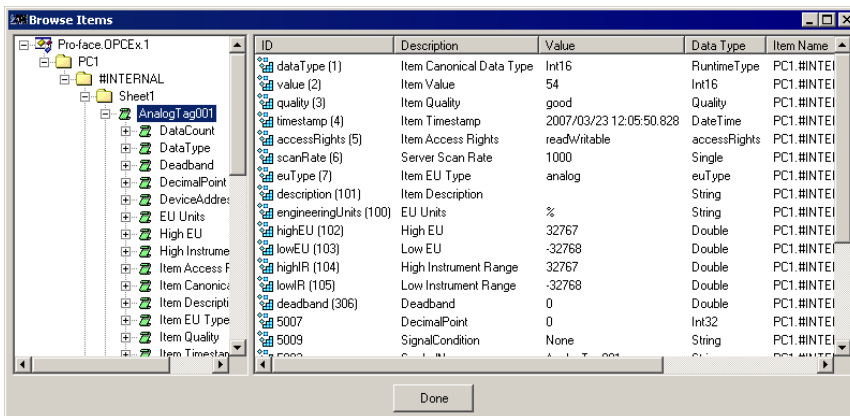

NOTE • For details on the item properties, refer to "2.5.4 Item Property ID".

4



Menu Configuration of the Configuration Tool

4.1 Menu Configuration of the Configuration Tool.....4-2

4 Menu Configuration of the Configuration Tool

4.1 Menu Configuration of the Configuration Tool

4.1.1 File Menu

New

If the current changed contents are not saved, a file of the same status is created as when the Configuration Tool is started (only the NPX node configuration is displayed, and no tag is registered) after the processing shown in the following "Tag Configuration Unsave Check".

Open

If the current changed contents are not saved, the tag configuration file selected in the "Open" dialog box is read after the processing shown in the following "Tag Configuration Unsave Check". At this time, check the consistency with NPX as shown in "Tag Configuration Consistency with NPX in 'Pro-Server EX'" to display the results.

Save

Save the relationship between the tag and symbol/device address as well as the tag-related parameters in the tag configuration file. If the changed tag information is included in the current tag configuration file, save that file. If a file is newly created (file name is not set), perform the same save operation using "Save As" to set the file name.

Save As

Save the relationship between the tag and symbol/device address as well as the tag-related parameters as the file name specified in the "Save As" dialog box in the tag configuration file. When a file which already exists is selected in this dialog box, the message to confirm whether to overwrite it is displayed. Only when "Yes" is selected for this message, save the file. When "No" is selected, the "Save As" dialog box remains displayed.

Exit

If the current changed contents are not saved, exit the Configuration Tool after the processing shown in the following "Tag Configuration Unsave Check".

- **Tag Configuration Unsave Check**

If the possibility of canceling the changes before saving them comes up (ex. when going to exit the Configuration Tool), the message asking you to save is displayed. Select the button displayed in the message box to save or cancel.

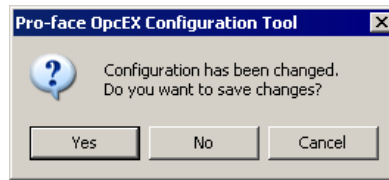

[Yes]: Save the changes and continue the operation.

[No]: Do not save the changes and continue the operation.

[Cancel]: Do not save the changes and cancel the operation.

- **Tag Configuration Consistency with NPX in 'Pro-Server EX'**

The tag configuration information is generated based on NPX of 'Pro-Server EX'. To use this information and operate the OPC Server properly, it must always be consistent with NPX information of 'Pro-Server EX'.

For this reason, the Configuration Tool checks the consistency of the tag configuration information with NPX when reading the current tag configuration file. The items to check are shown below:

- 1) File name and version with those for NPX of 'Pro-Server EX'
- 2) Node and symbol registration status with those for NPX of 'Pro-Server EX'

The NPX version changes regardless of the tag configuration (by Action or Trigger condition), so you cannot judge if there is any consistency problem with the tag configuration information only by comparing the version. To check the strict consistency, you need to also check the node or symbol registration status with those for NPX in addition. The items to check in terms of consistency of the tag configuration information with NPX are as follows:

- 1) Difference or existence of the node name or type
- 2) Difference or existence of the device name or type
- 3) Existence of the sheet name
- 4) Difference or existence of the type or number for the symbol name or device address

These results tell the users about any registration differences. This process allows you to judge whether you loaded the wrong NPX or failed to update the tag configuration information.

4.1.2 Edit Menu

Delete

Delete the symbol or device address information tagged with the Configuration Tool. To delete, select the tag you want to delete in the Station Explorer or Parameter View and select the [Delete] menu. Then, the following confirmation message is displayed:

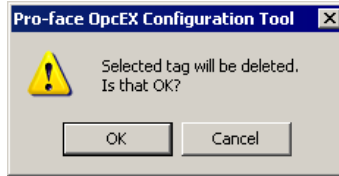

Click [Yes] in the confirmation message to delete the selected tag. Note that this menu is invalid in the ItemID View.

You can delete the symbol group registered as the tag due to consistency with NPX, but cannot delete individual registration descriptions under it.

Rename

To change the current tag name, select the tag or tag group that you want to change names of on the Station Explorer, and select the [Change Name] menu. Then, you can edit the selected tag or tag group on the Station Explorer.

Enter the desired name, and press the Enter key or move the input focus to set the entry (it is also set when another control is selected). Note that you cannot change the name of the symbol registered as the tag. If the changed tag has no error (ex. there is the same tag name on the same level), the name is changed.

If there is an error, the error message is displayed, and requires entry.

Add Tag Group

When you select the node showing the device or tag group on the first level on the Station Explorer to select the [Add Tag Group] menu, or select [Add Tag Group] from the shortcut menu displayed by right-clicking the node, you can add a tag group.

Note that you cannot add the symbol group registered as the tag group. When you select these menus, the name 'NewTagGroup*' (* shows the number of tag group in the same level + index 1) is added as default directly under the node of a new tag group.

You can add up to two levels for any tag group. If the added tag group has no error (ex. there is the same name on the same level), the name is changed. If there is an error, the error message is displayed, and requires entry.

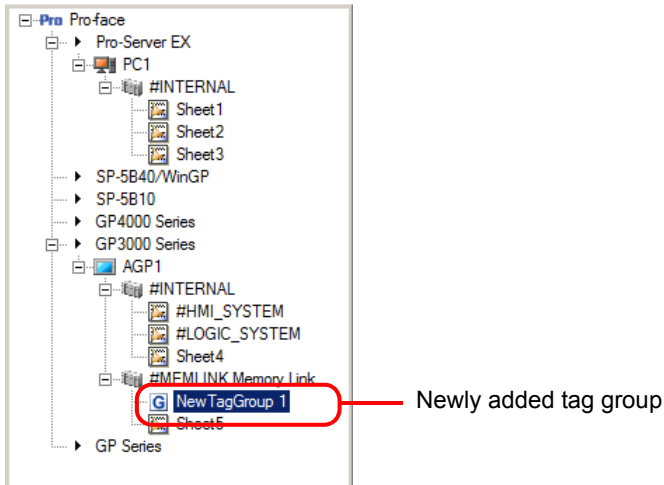

Add Tag

Add a new tag in the level of the device or tag group selected in the Station Explorer. When you select the [Add Tag] menu, the following dialog box is displayed to allow you to set a new tag name and the symbol or device address to tag.

The name 'NewTag*' (* shows the number of tag in the same level + index 1) is set in the [Tag] item as default. In the [Device Address] item, you can enter the symbol or device address to unite the tag name shown in the [Tag] item manually using the calculator icon (data type icon) or symbol icon.

When you tag the symbol, the symbol name is registered as a tag name as it is. Therefore, you cannot change the tag name at the point of confirming the symbol name entry, and the tag name is displayed in gray.

In addition, set the comment you set in the symbol registration in 'Pro-Studio EX' as default in the [Description] item.

If the added tag has no error (ex. there is the same name on the same level), the tag is added with its name. If there is an error, the error message is displayed, and requires entry (Your entry is confirmed when the focus moves from the device address). You can add a tag using the dialog box, so you do not need to open or close the dialog box every time you add a tag. You can click [Add] on the dialog box to add a new tag without closing the dialog box.

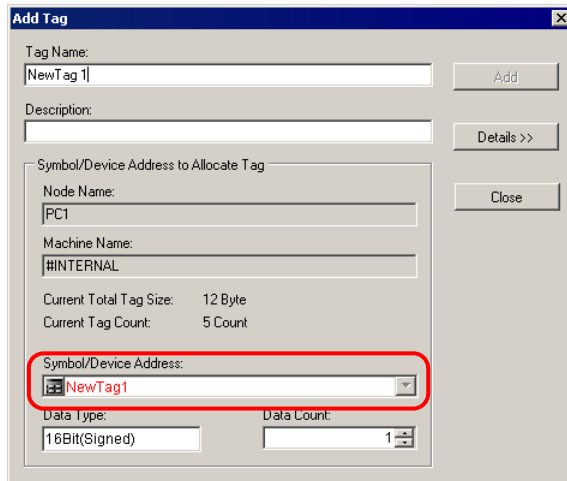

- IMPORTANT** • Since 'Pro-Server EX' has the limitation that one cache buffer is available per device, you cannot add a tag of which the cache size exceeds 10K bytes (10x1024 bytes). Set the total number of tags in a device to be 1000 or less.

Find Tag

Search the tags registered on the tag configuration and display the result on the tag search results. When you select the node, device, the level node of the tag group of which you want to search any tags on the Station Explorer and operate the [Find Tag] menu, the following tag search dialog box is displayed:

Set the tag you want to search for using the character string under [Search Tag]. You can include the wildcard character '*' or arbitrary character '?' in the search character string, so you can search all tags including the corresponding parts, even if you know only a part of the name. In addition, you can select the search character string from the history because the latest 20 history can be recorded.

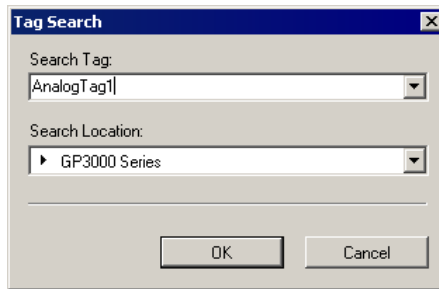

The level node selected on the Station Explorer is set in [Search Location]. You can change the search location without closing the [Tag Search] dialog box.

As shown below, such levels as displayed on the Station Explorer are also displayed.

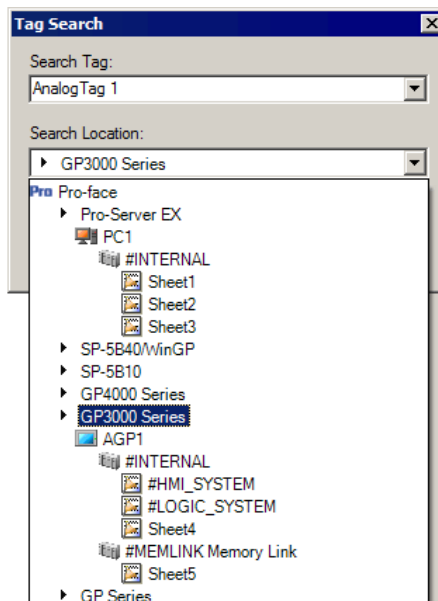

NPX Symbol Import

You can automatically register several thousands or tens of thousands of symbols registered in the current NPX as the tags, without registering them by one as described in the [Add Tag] section.

When you select the node or device displayed on the Station Explorer, and operate the [NPX Symbol Import] menu, the following [NPX Symbol Import] dialog box is displayed, listing the [Name] items and [Description] items:

You can select multiple items on the list and sort the [Name] items in ascending order to select the import source freely. Select the desired [Name] item and click [OK] to import the symbols from NPX and start the tag registration.

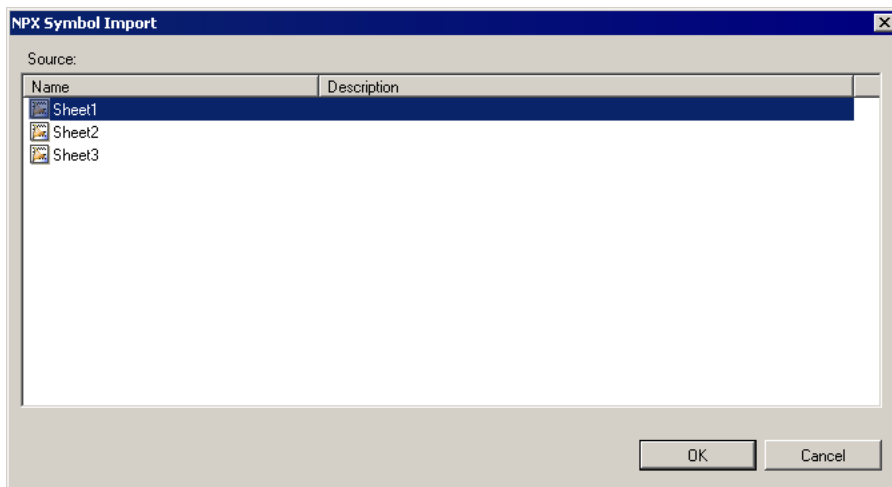

In [NPX Symbol Import], all NPX symbols are not set as target unconditionally, but the importing source targets are set depending on the node selected on the Station Explorer.

The relationship between the node selected on the Station Explorer and the importing source is shown below:

Selected node on the Station Explorer	NPX importing target
Node type (ex. 'Pro-Server EX' node)	All nodes registered under it
Node (ex. AGP1)	All devices registered under it
Device (ex. PLC1)	All sheets registered under it
Sheet (ex. Sheet1)	All symbols or symbol groups registered under it
Tag Group	Not available
Tag	Not available

If the same tag is registered on the Configuration Tool, a symbol is not imported, but skipped.

4.1.3 Display Menu

Station Explorer

Switches the currently displayed tree area to the Station Explorer.

ItemID View

Switches the currently displayed tree area to the ItemID View.

Error List

Makes the [Error List] tag selected and displays the error list at the front.

Tag Search Result

Makes the [Tag Search List] tag selected and displays the tag search result at the front.

4.1.4 OPC Server Menu

Shutdown

Notifies the shutdown request to the OPC Server when the OPC Server is running. To shut down the running OPC Server, this menu displays the following message to warn the users just before notifying the OPC Server to shut down. When you select [Yes], the shutdown is notified to the OPC server is shut down.

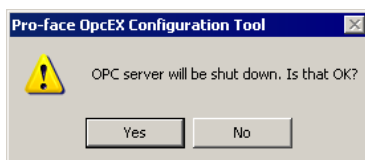

OPC Server Configuration Settings

Configures the settings related to the OPC Server operation or environmental configuration. The configured information is saved as a configuration file in a folder in which the OPC Server is installed. The configuration file name is "OpcConfiguration.xml". The changed contents are enabled when restarting the OPC Server.

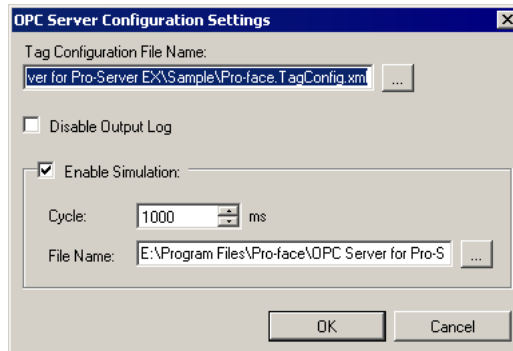

The OPC Server configuration item description is shown below.

- **Tag Configuration File Name**

Specify the current tag configuration file applied to the OPC Server with a full path. You can also select the [...] button on the right of the [Tag Configuration File Name] text box to specify the tag configuration file from the file selection dialog box.

- **Disable Output Log**

The OPC Server records the operation status in the log viewer of 'Pro-Server EX'. If you check the "Disable Output Log" option, it cancels recording.

This function is enabled when operating the OPC Server on Windows XP embedded system equipped with auxiliary storage devices that have write limitations, including CF card.

- **Enable Simulation**

Set whether to enable the OPC Server simulation function. Check the box to enable the simulation function. The simulation function works for the targets with the simulation setting corresponding to each data type except None in the tag parameter settings.

When the simulation is enabled, you can set the items of "Cycle" and "File Name" items.

- **Cycle**

Set the simulation rate in 100ms. The setting range is the same as that of the "Pro-Server EX Cache Buffer Collection Rate".

- **File Name**

The OPC Server can generate simulation data from a CSV format file. You can press the [...] button on the right of the [File Name] text box to specify a CSV format file name from the file selection dialog box.

Scan Cycle List Settings

You can set the scan cycle to collect the tag data. To set the scan cycle, select from the scan cycle list. The scan cycle list consists of the [Output only] option and nine types of changeable cycles.

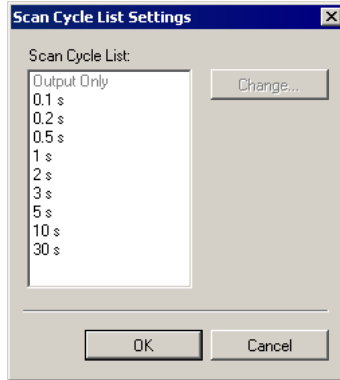

The setting contents of the scan cycle list are described as below:

- Output Only**
 You cannot change the [Output Only] option. Specify this option for the write tag of which you do not need to collect the data.
- Scan Cycle Changes**
 You can change the contents of the scan cycle list. When you select the value you want to change and click [OK], the [Scan Cycle Changes] dialog box is displayed.
 You can directly enter the desired rate in the [Scan Cycle] text box, or click the spin button to change the scan rate.
 The scan cycle is changeable between 100 ms and 6553.5 s in 100 ms. When you finish setting, click [OK].
 You can also change the multiple scan cycle lists simultaneously.

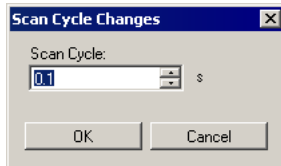

- Confirming the Changed Scan Cycle**
 When you change the scan cycle, the scan cycle you have set is displayed in the changed list position.
 When you click [OK], the following confirmation message is displayed. Click [OK] in this confirmation message box to change the scan cycle.

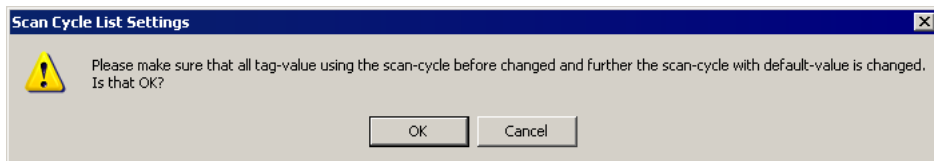

4.1.5 Tool Menu

Option

Set the default detailed tag parameters used in the [Add Tag] dialog box or [NPX Import Symbol]. You can set the default value for each data type of the tags to register.

NOTE • The displayed parameters and setting range depend on the data type. Refer to "2.5.1 Detailed Tag Parameters" for more details.

Registering Default

- 1 Select [Option] from the [Tool] menu to display the [Option] dialog box.

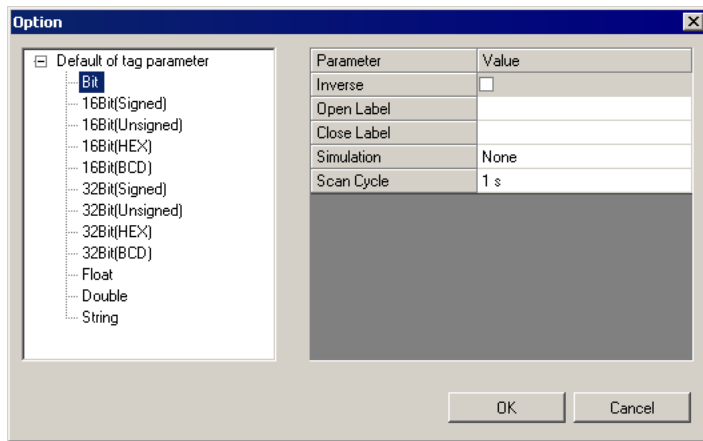

- 2 Select the data type from the tree display on the left of the screen.

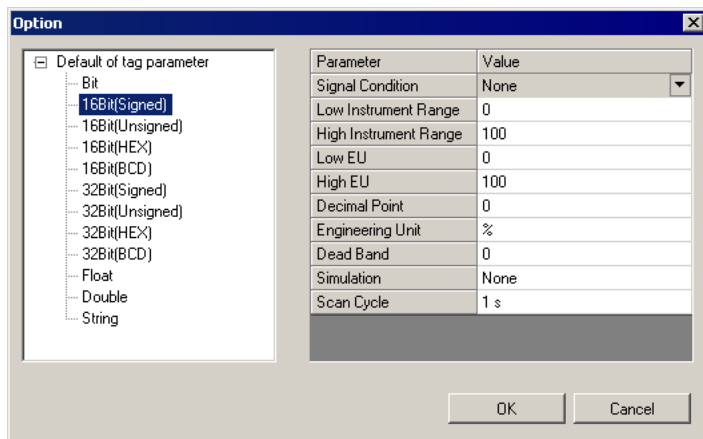

- 3 Double-click the parameter from the grid display on the right of the screen to prepare for entry.

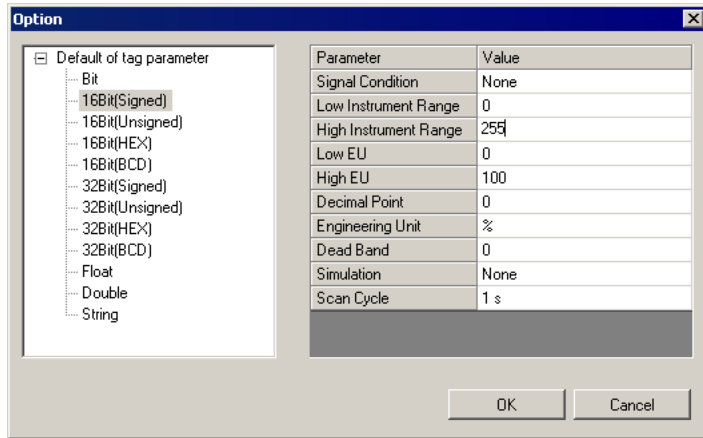

NOTE • You can press the  button to display the parameter list.

- 4 Enter the setting value, and press the [Enter] key to confirm the entry.

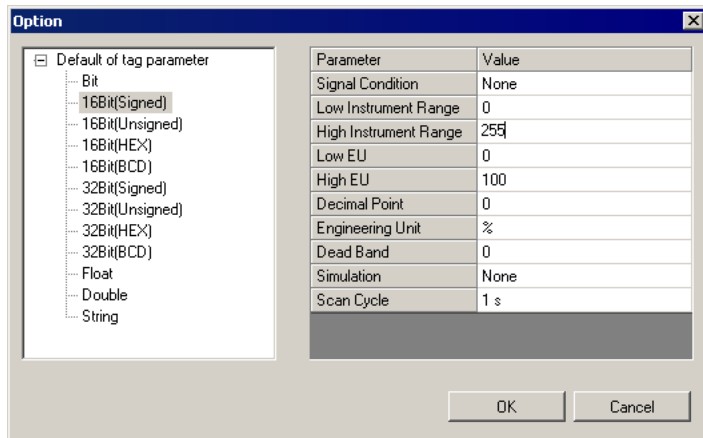

Set other parameters using the same procedure.

NOTE • Your entry from the list is confirmed when you click the item.
• Your entry in the checkbox is confirmed when you click the box.

- 5 Click [OK] to finish setting.

4.1.6 Help Menu

Reference Manual

Displays this manual, the 'OPC Server for Pro-Server EX Reference Manual'.

About Version

Displays the version information of the 'OPC Server for Pro-Server EX'.



5



Error Information

5.1 Error Information5-2

5 Error Information

5.1 Error Information

5.1.1 OPC Server Error Information

The OPC Server records the operation status in the Pro-Server EX Log Viewer. The log is recorded in the normal mode (non-simulation mode).

For details on the Log Viewer, refer to the Pro-Server EX Reference Manual.

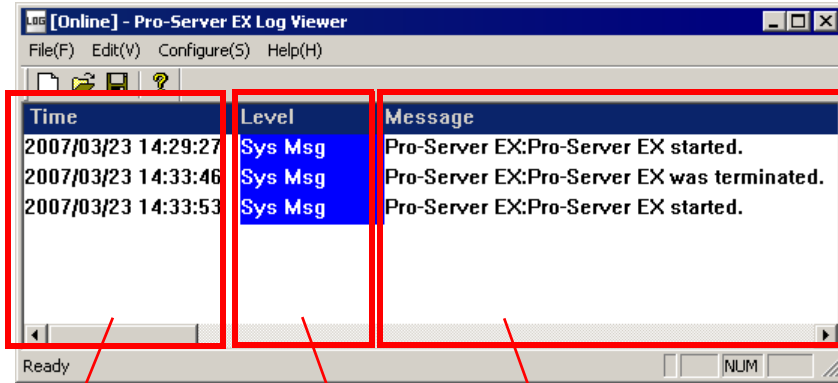

Displays Date and Time

Log Type

Displays Log Description

The log displayed in the Log Viewer includes the one 'Pro-Server EX' outputs and the one the OPC Server outputs. The log type list is shown below.

Log Type	Log Viewer Display	Description
System Message	Sys Msg	System event log that 'Pro-Server EX' outputs
System Error	Sys Err	Error message that 'Pro-Server EX' outputs
Application Error	Error	Error message that the OPC Server outputs
Application Start	Start	OpcEX start message that the OPC Server outputs
Application End	End	OpcEX exit message that the OPC Server outputs
Application Warning	Warning	OpcEX warning message that the OPC Server outputs
Application Message1	Message1	Reserved
Application Message2	Message2	Reserved

You can restrict the log displayed in the Log Viewer in the "Log Property" dialog box. To display the OPC Server error log, check the following items.

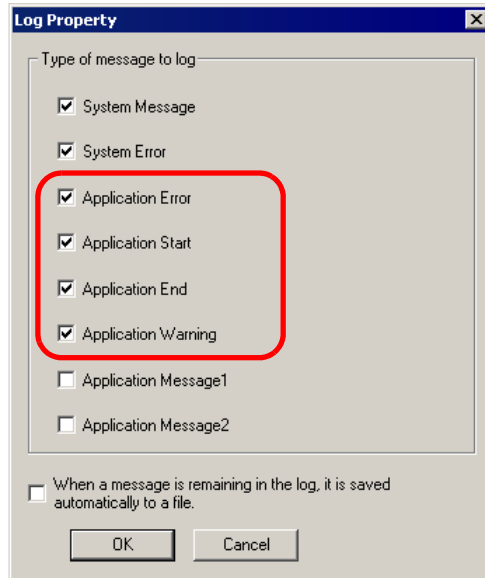

The [Application Start] and [Application End] are displayed once when the OPC Server starts and exits respectively.

When an error or warning occurs on the OPC Server after startup, the [Application Error] and [Application Warning] show the description.

In addition, if an error occurs during the startup process when the OPC Server loads the tag configuration file and generates the device item, the OPC Server outputs the detailed error causes to the error log file (Error.log). The file save location, file name, and output description are shown below.

File Save Location	In the folder "ErrorLog" where the OPC Server is installed
File Name	Error.log
Creating Method	Add
Output Description	Day/Time
	OLE Error Code
	Function
	Device Cache Name
	ItemID
	Property
	Message

The output file example is shown below.

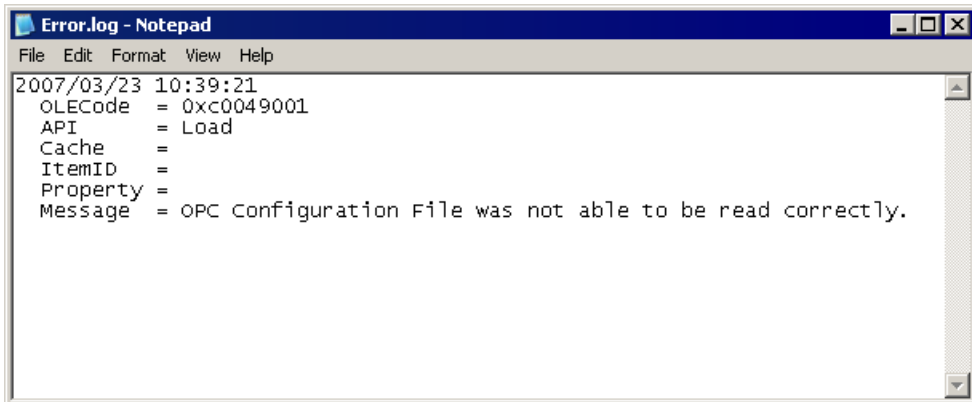

The error description specific to the OPC Server is shown below.

Error Code	Error Message	Cause and Troubleshooting
0xC0B00731	Failed to read the OPC-configuration file properly.	The configuration file does not exist, or the XML syntax includes an error. Start the Configuration Tool and select [OPC Server Configuration] from the [OPC Server]. Then, create the configuration file from the "OPC Server Configuration" dialog box. If it does not solve the problem, please install 'OPC Server for Pro-Server EX' again.
0xC0B00732	Error exists in the OPC-configuration file.	The configuration file contains an error description. Start the Configuration Tool and select [OPC Server Configuration] from the [OPC Server]. Then, create the configuration file from the "OPC Server Configuration" dialog box. If it does not solve the problem, please install 'OPC Server for Pro-Server EX' again.
0xC0B00733	Failed to read the tag-configuration file properly.	The tag configuration file does not exist, or the XML syntax includes an error. Start the Configuration Tool and select [OPC Server Configuration] from the [OPC Server]. Then, specify the tag configuration file from the "OPC Server Configuration" dialog box, and click [OK]. If this does not solve the problem, start the Configuration Tool, select [Open] from the [File] menu. Specify the tag configuration file to use, and check if the file has no errors. If an error occurs, correct it on the Configuration Tool, or create a new tag configuration file.
0xC0B00734	NPX information loaded by Pro-Server EX does not match that (NPX-file name or build number) in the tag-configuration file.	The NPX loaded by 'Pro-Server EX' does not match NPX information described in the tag configuration file. Start the Configuration Tool, select [Open] from the [File] menu, and specify the tag configuration file to use. If the NPX file name is different, change the tag configuration file to use, or change NPX loaded by 'Pro-Server EX'. If the build number is different, save the tag configuration file using the Configuration Tool.

Error Code	Error Message	Cause and Troubleshooting
0xC0B00735	Simulation CSV file could not be imported correctly.	There is no simulation CSV file in the simulation mode. Start the Configuration Tool, and select [OPC Server Configuration] from the [OPC Server]. Then, specify the simulation file name from the "OPC Server Configuration" dialog box, and click [OK].
0xC0B00736	Tag in the tag-configuration file is incorrect.	The tag configuration file contains an error description. Start the Configuration Tool, select [Open] from the [File] menu, and specify the tag configuration file to use. If an error is displayed, correct it. If an error is not displayed, create a new tag configuration file with the Configuration Tool.
0xC0B00737	Same tag already exists.	The tag configuration file contains tags with the same ItemID. Start the Configuration Tool, select [Open] from the [File] menu, and specify the tag configuration file to use. If an error is displayed, correct it. If an error is not displayed, create a new tag configuration file with the Configuration Tool.
0xC0B00738	Failed to generate device cache.	Restart 'Pro-Server EX'. If it does not solve the problem, please install 'OPC Server for Pro-Server EX' again.
0xC0B00739	Attribute in the tag-configuration file is incorrect.	An attribute in the tag configuration file has an error. Start the Configuration Tool, select [Open] from the [File] menu, and specify the tag configuration file to use. If an error is displayed, correct it. If an error is not displayed, create a new tag configuration file with the Configuration Tool.
0xC0B0073A	Failed to get the handle of ProServer.	Failed to get the Pro-Server EX handle. Restart the OPC Server and 'Pro-Server EX'. If it does not solve the problem, please install 'OPC Server for Pro-Server EX' again.
0xC0B0073D	Failed to get message from message DLL.	Failed to get any message from the message DLL. Please install 'OPC Server for Pro-Server EX' again.

5.1.2 Configuration Tool Error Information

The error description specific to the Configuration Tool is shown below.

Error Code	Error Message	Cause and Troubleshooting
0xC0B00751 SAAM081 -1062205615 3232761681	Does not match the Node type in NPX.	The node type registered in the tag configuration is different from that in NPX. Check the node registration in NPX.
0xC0B00752 SAAM082 -1062205614 3232761682	No Node registered in NPX.	The node name registered in the tag configuration is not registered in NPX. Check the node registration in NPX.
0xC0B00753 SAAM083 -1062205613 3232761683	No device registered in NPX.	The device registered in the tag configuration is not registered in NPX. Check the device registration in NPX.
0xC0B00754 SAAM084 -1062205612 3232761684	No symbol sheet registered in NPX.	The symbol sheet registered in the tag configuration is not registered in NPX. Check the symbol sheet registration in NPX.
0xC0B00755 SAAM085 -1062205611 3232761685	No symbol registered in NPX.	The symbol name registered in the tag configuration is not registered in NPX. Check the symbol registration in NPX.
0xC0B00756 SAAM086 -1062205610 3232761686	Device address does not match NPX symbol registration.	The device address of the symbol registered in the tag configuration does not match that in NPX. Check the symbol registration in NPX.
0xC0B00757 SAAM087 -1062205609 3232761687	Invalid device address.	Set the tag symbol or device address again.
0xC0B00758 SAAM088 -1062205608 3232761688	Tag name and symbol name do not agree.	Set the tag name and symbol name to the same name.
0xC0B00759 SAAM089 -1062205607 3232761689	Does not match the symbol data type registered in NPX.	Set the tagged symbol in the tag configuration and the NPX symbol to the same data type.
0xC0B0075A SAAM090 -1062205606 3232761690	Does not match the symbol data count registered in NPX.	Set the tagged symbol in the tag configuration and the NPX symbol to the same data count.
0xC0B0075C SAAM092 -1062205604 3232761692	Tag name is same as a symbol-sheet name in NPX.	Set the tag name of the device address registered in the tag configuration not to be same as the NPX symbol sheet name.
0xC0B0075D SAAM093 -1062205603 3232761693	Registered as a group array in NPX.	The tag group of the symbol registered in the tag configuration is registered as an array in NPX.

Error Code	Error Message	Cause and Troubleshooting
0xC0B0075E SAAM094 -1062205602 3232761694	Exceeded the maximum number of tags registered in a device (1000).	Set the total number of tags in a device to be 1000 or less.
0xC0B0075F SAAM095 -1062205601 3232761695	Exceeded the maximum total size of tags registered in a device (10240bytes).	Set the total byte of tags in a device to be 10240 bytes or less.
0xC0B00771 SAAM113 -1062205583 3232761713	{0:s} value '{1:s}' is invalid.	Invalid value is set. Set a valid value.
0xC0B00772 SAAM114 -1062205582 3232761714	{0:s} value '{1:s}' is out of range. Not listed.	Set within the listed value range.
0xC0B00773 SAAM115 -1062205581 3232761715	{0:s} value '{1:s}' is invalid as a numeric value.	Set a valid value as a numeric value.
0xC0B00774 SAAM116 -1062205580 3232761716	{0:s} Set a numeric value from {1:s} to {2:s}.	Set a numeric value within the setting range.
0xC0B00775 SAAM117 -1062205579 3232761717	{0:s} Set a character count from {1:s} to {2:s}.	Set the number of characters within the setting range.
0xC0B00776 SAAM118 -1062205578 3232761718	{0:s} Prohibited character {1:s} contained.	Do not use the prohibited characters.
0xC0B00777 SAAM119 -1062205577 3232761719	Value '**' is invalid as a numeric value.	Set a numeric value within the setting range.
0xC0B00781 SAAM129 -1062205567 3232761729	Cannot add. Exceeded the maximum number of tags registered in a device (1000).	Set the total number of tags in a device to be 1000 or less.
0xC0B00782 SAAM130 -1062205566 3232761730	Cannot add. Exceeded the maximum total size of tags registered in a device (10240bytes).	Set the total byte of tags in a device to be 10240 bytes or less.
0xC0B00784 SAAM132 -1062205564 3232761732	'**' already exists. Cannot add or change. (** : Tag name to add or change)	Set as a different name.
0xC0B00785 SAAM133 -1062205563 3232761733	'**' contains a group array. Cannot add. (** : Symbol Name)	You cannot add a group array.

Error Code	Error Message	Cause and Troubleshooting
0xC0B00786 SAAM134 -1062205562 3232761734	Cannot import symbols. Item type does not match.	Set so that the item type is same in the tag configuration and NPX.
0xC0B00787 SAAM135 -1062205561 3232761735	OPC server not installed.	Please reinstall.
0xC0B00788 SAAM136 -1062205560 3232761736	Failed to connect to OPC server. *** (***: Cause to fail)	Please reinstall.
0xC0B00789 SAAM137 -1062205559 3232761737	Shutdown request failed. *** (***: Cause to fail)	Check if 'OPC Server for Pro-Server EX' shuts down with the task manager. If it does not shut down, force quit 'OPC Server for Pro-Server EX' from the task manager.
0xC0B0078A SAAM138 -1062205558 3232761738	File '***' not found.	Please check if the ** file exists. If it is not the tag configuration file, reinstall.
0xC0B0078B SAAM139 -1062205557 3232761739	I/O error. *** (***: Cause of error)	Solve the cause of error, such as disk capacity shortage or improper disk preparation, and perform again.
0xC0B0078C SAAM140 -1062205556 3232761740	Security error. *** (***: Cause of error)	Check the cause of error, following the message directions.
0xC0B0078D SAAM141 -1062205555 3232761741	Access error. *** (***: Cause of error)	Check if you have the right to access, or the file is read only.
0xC0B0078E SAAM142 -1062205554 3232761742	Schema validation error. *** (***: Cause of error)	Check the cause of error, following the message directions.
0xC0B0078F SAAM143 -1062205553 3232761743	Invalid XML document. *** (***: Cause of error)	Check the cause of error, following the message directions.
0xC0B00790 SAAM144 -1062205552 3232761744	Cannot save the tag configuration because the empty NPX is loaded in Pro-Server EX. Load NPX which is not empty in 'Pro-Server EX', and save.	Load NPX which is not empty in 'Pro-Server EX'.

6



Inquiry

6.1 Inquiry6-2

6.1 Inquiry

Do you have any questions about difficulties with OPC Server for Pro-Server EX?

Before contacting us

Introducing "Otasuke Pro!" which is the site that offers support for Pro-Server EX products

"Otasuke Pro!" is loaded with contents to support your questions and requests. Please access our site anytime that you need help with a solution.

<http://www.proface.com/otasuke/>